

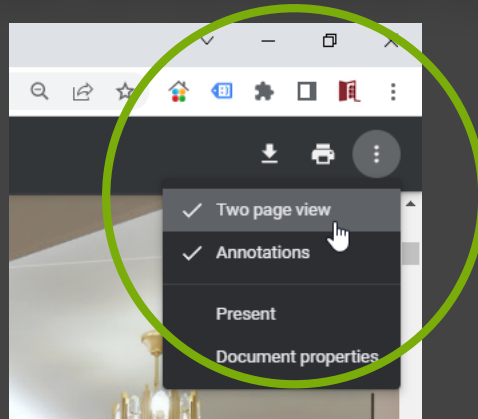

CATALOG UȘI INTERIOR ITALSTYL

e-book (PDF)

pentru o experiență cât mai bună pe LAPTOP/DESKTOP activați vizualizare pe 2 pagini



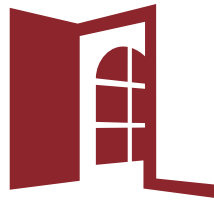
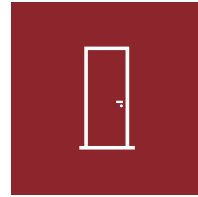

ITALSTYL

Lemn prin excelență

uși de interior

 **ITALSTYL**

Uși interior



ITALSTYL

Lemn prin excelență

ITALSTYL

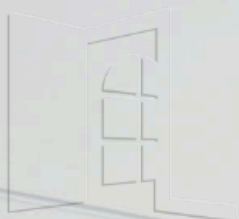

ITALSTYL

I N D E X

Despre 02

Uși interior 05

Tipuri de uși 06

Modern 09

Style 39

Baroc 51

Sara 65

Graf 75

E-line 93

Tocuri de trecere 101

Pervaze și capiteluri 105

Uși pentru hoteluri 115

Finisaje 124

Tipuri / profile 128

Structură uși 130

Accesorii 132

Uși glisante 134

Portofoliu 142

Contact 173

Noi suntem
ITALSTYL

De mai bine de 18 ani de când am pornit la drum, am avut întotdeauna în vedere două principii cu care am venit în întâmpinarea celor ce vin la noi și aleg să colaborăm - să respectăm clienții prin calitate și să aducem noul în prim plan. Am înțeles că pentru a avea succes e nevoie mai întâi de toate să te adaptezi cerințelor momentului și să dobândești confirmarea venită din partea oamenilor care au încredere și folosesc produsele noastre în viața de zi cu zi. Pentru cei ce ne aleg, ne propunem să venim cu soluția cea mai potrivită, pentru a răspunde așteptărilor fiecăruia. Prin comunicare directă și prin experiența acumulată în timp, urmărim să obținem de fiecare dată cea mai bună finalitate, la un înalt nivel calitativ. Urmărim să fim cât mai aproape de excelență din punct de vedere tehnic și estetic. Suntem deschiși la inovație și ne propunem să vă ajutăm să vă transformați casa în căminul unic și confortabil pe care vi l-ați dorit atât de mult. Am dezvoltat o adevărată pasiune pentru calitate ce poate fi regăsită în cele mai mici detalii, care, de cele mai multe ori, fac diferența. Pentru noi, fiecare produs este o experiență unică, acordându-i-se o deosebită atenție de-a lungul drumului de la schiță până la final, de la lemnul brut până la finisaje. Astfel, clienții noștri au satisfacția calității, a lucrului bine făcut, chiar și după ani de folosință, fie că este vorba despre uși de interior, uși de intrare, ferestre sau parchet.



Uși de interior

Ușile de interior create de noi sunt concepute pentru a se integra perfect în ambientul din care vor face parte, remarcându-se prin calitatea ridicată a materialelor, finisajelor și prin designul deosebit.

Din punct de vedere al sistemului de fabricație, dar și al designului, de inspirație clasică sau modernă, modelele de uși de interior sunt grupate în 6 game diferite: Modern, Style, Baroc, Sara, Graf, E-line.

În acest catalog vă prezentăm doar o mică parte din ceea ce vă putem oferi, tocmai datorită faptului că ne-am propus să fim deschiși și să răspundem oricăror provocări ale imaginației și bunului gust ale fiecăruia dintre dumneavoastră.

Tipuri de uși de interior

UȘI BATANTE

UȘI BATANTE 1 CANAT

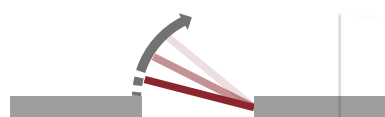
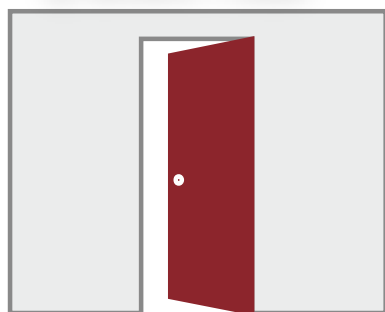

UȘI BATANTE 2 CANATURI

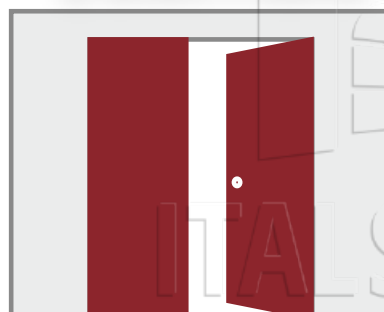

UȘI GLISANTE

UȘI GLISANTE INTERIOR PERETE

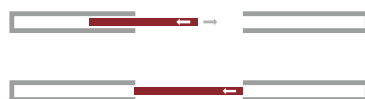
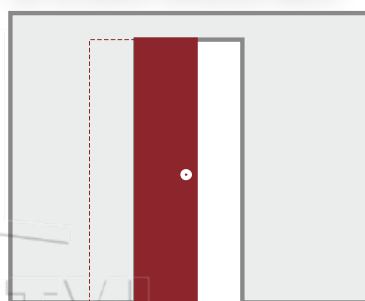

UȘI GLISANTE 2 CANATURI

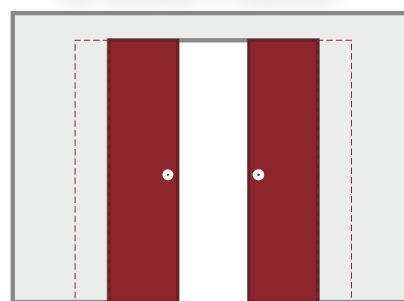

**UȘI TELESCOPICE - INTERIOR PERETE
2 CANATURI**

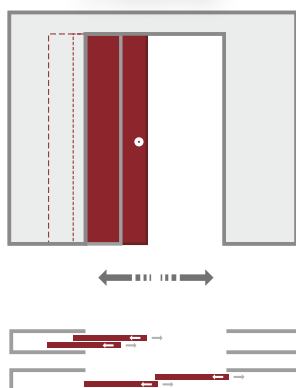

**UȘI GLISANTE EXTERIOR PERETE
1 CANAT**

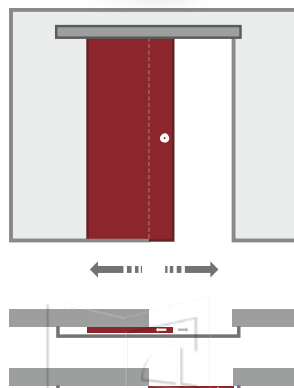

**UȘI GLISANTE ÎNTRE PEREȚI -
2 CANATURI (1 FIX - 1 MOBIL)**

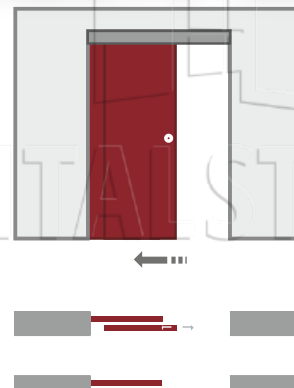

**UȘI TELESCOPICE - INTERIOR PERETE
4 CANATURI**

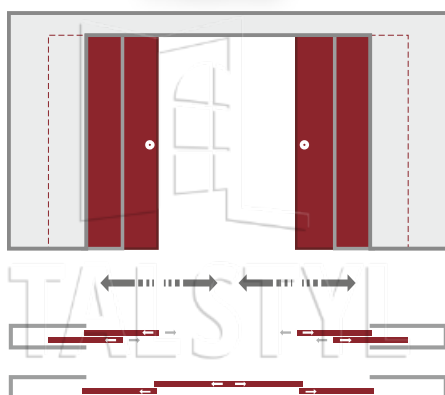

**UȘI GLISANTE EXTERIOR PERETE
2 CANATURI**

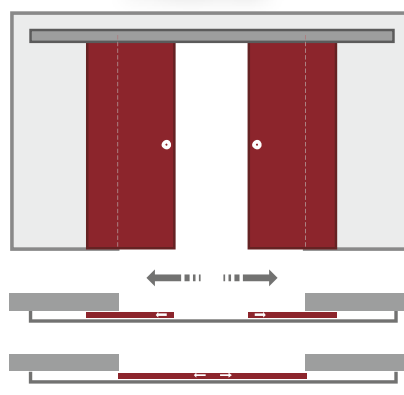

**UȘI GLISANTE ÎNTRE PEREȚI -
2 CANATURI (DUBLU SENS)**

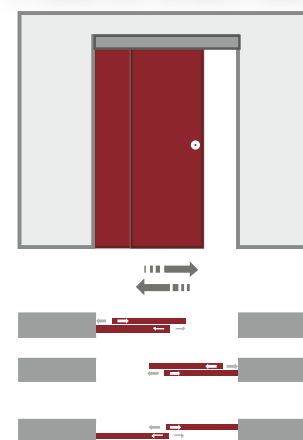

►► **Detalii uși glisante: pag. 134**



gama
MODERN

Ușile de interior din gama Modern sunt alegerea potrivită pentru un ambient contemporan, în care nota dominantă este geometria simplă caracteristică designului minimalist. Ușile se integrează perfect interioarelor care poartă amprenta noutăților tehnologiei și stilului de viață dinamic și activ.

Gama MODERN - DESCRIERE

■ FOAIE DE UȘĂ - grosime 44 mm - este construită dintr-un cadru din lemn masiv rășinos îmbinat în dinți sau amestec (rășinos plus foioase), cu interior din structură celulară (carton celular ceruit care conferă stabilitate și determină reducerea greutateii foii de ușă) placată la exterior cu MDF grosime 4 mm furniruită cu furnir din lemn natural de stejar în cazul culorilor băițuite.

În cazul vopsirii în culori RAL por deschis ușile vor fi furniruite cu furnir din lemn natural de frasin.

În cazul vopsirii în culori RAL por închis vopsirea se realizează direct pe suprafața de MDF a ușii.

■ TOC - (40 mm grosime / 100 mm lățime) - construit din panel lemn stratificat rășinos (5 straturi) furniruit cu furnir din lemn natural (după caz).

Tocurile sunt echipate cu garnituri de etanșare (albe sau maro, după caz).

■ PERVAZURI reglabile - construite din lemn multistrat / MDF / MDF bipres furniruite cu furnir din lemn natural (după caz).

■ CĂPTUȘELI reglabile - construite din MDF grosime 10 mm x lățime (după caz) furniruit cu furnir din lemn natural (după caz).

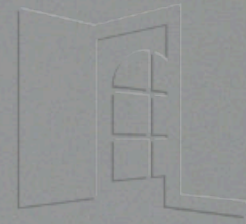

ITALSTYL



ITALSTYL



MODEL:
MODERN 29



MODEL:
MODERN 30-2i0



MODEL:
MODERN 29-FP

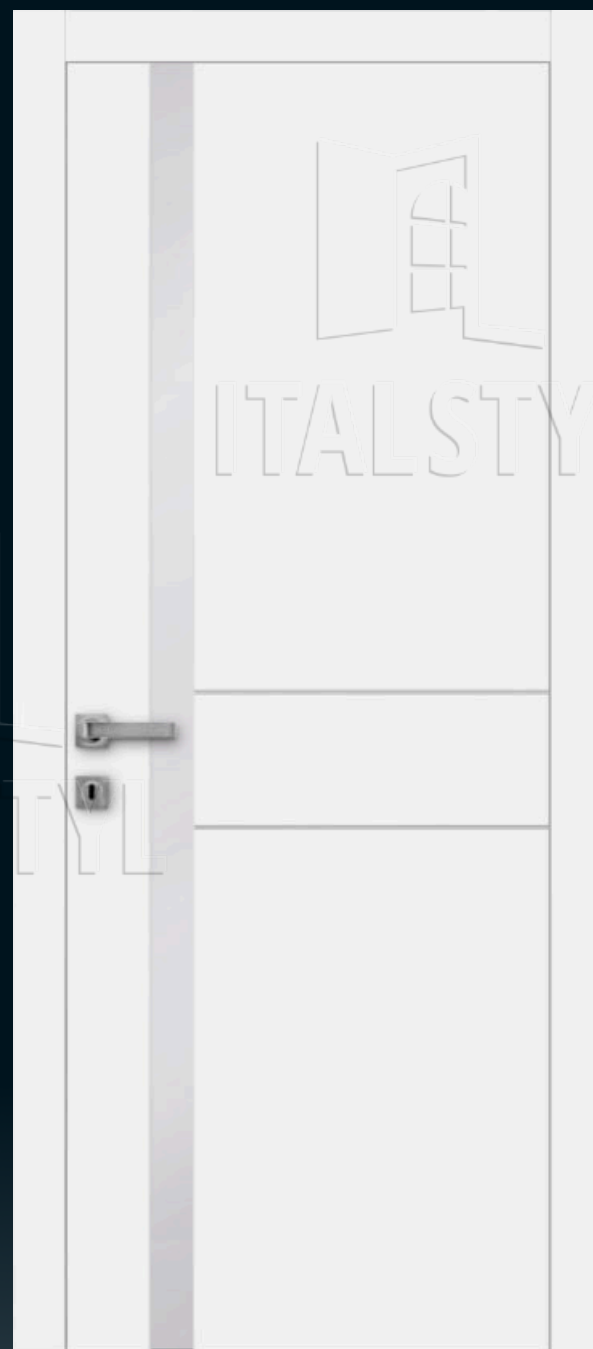

MODEL:
MODERN 30-FP

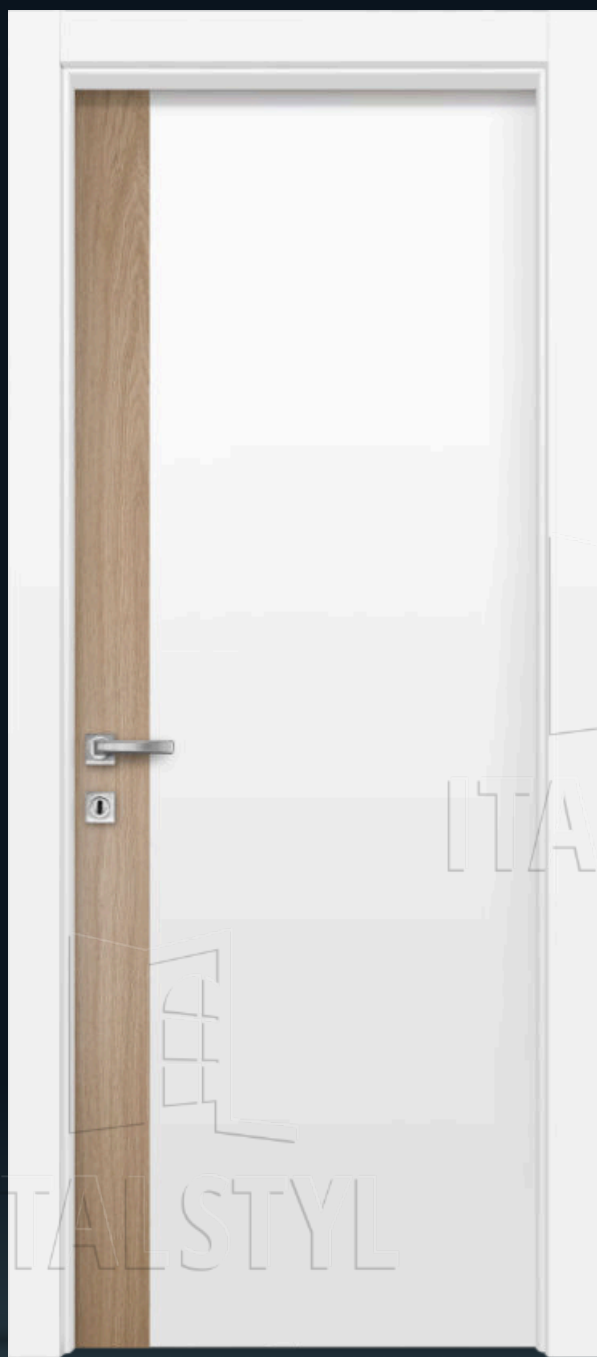

MODEL:
MODERN 1-1MV



MODEL:
MODERN 1-1MVN



MODEL:
MODERN 1-1SV



MODEL:
MODERN 1-1SVM



MODEL:
MODERN 1-FN-FP



MODEL:
MODERN 1-FP

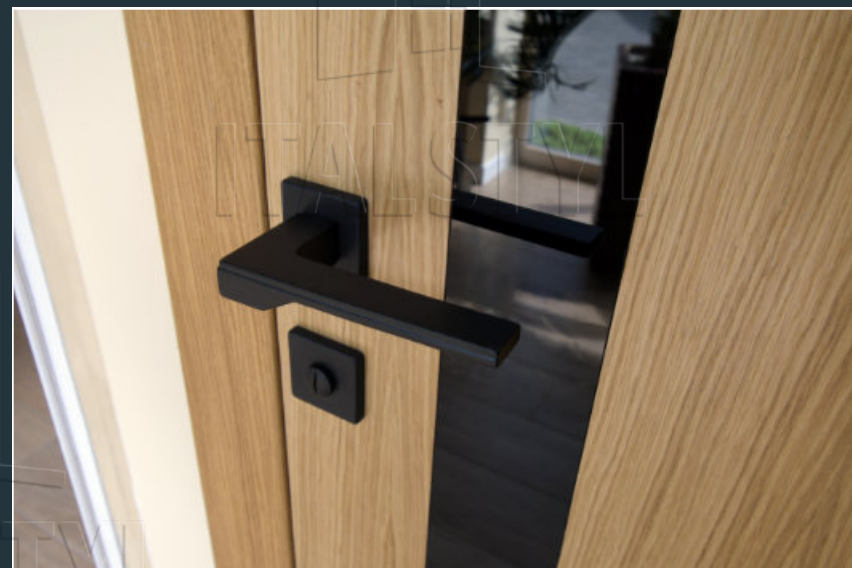

DETALII



MODEL:
MODERN 1-1SV-FP



MODEL:

MODERN 1-1SV



MODEL:
MODERN
1-1SVM

DETALIU





MODEL:
MODERN 30-2iO



MODEL:
MODERN 30S-2iO



MODEL:
MODERN 30-1iO



MODEL:
MODERN 29



MODEL:
MODERN 30-4NO



MODEL:
MODERN 1-4NO



MODEL:
MODERN 1-4iO



MODEL:
MODERN 6-3i0



MODEL:
MODERN 6

**Nou în gama
MODERN**

MODEL:
MODERN 1-1SV-FP

MODEL:
MODERN 1-FM
(FILO-MURO)

**Nou în gama
MODERN**

MODEL:
MODERN 1-1SVM





**MODEL:
MODERN
1-FN**

**TEXTURĂ NOUĂ:
noduri**

noduri



MODEL:

MODERN 1-4NO-FN

NOU ÎN GAMA MODERN

Noile modele de uși de interior din gama MODERN sunt definite de textura specială cu noduri, având rol decorativ, ceea ce subliniază faptul că esența lemnoasă este naturală și le conferă un aspect premium.



MODEL:
MODERN 3-2iO



MODEL:
MODERN 3-4NO



MODEL:
MODERN 3-4i0



MODEL:
MODERN 2A

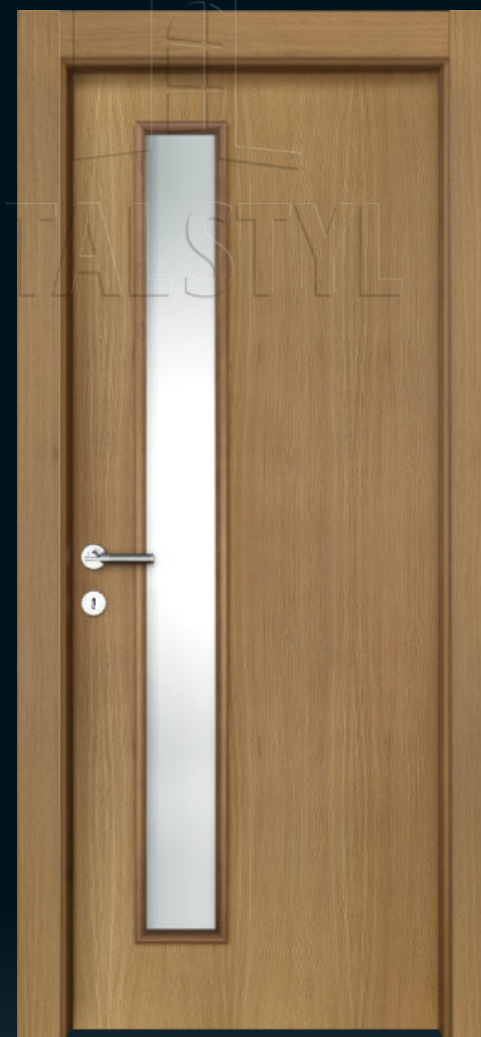

MODEL:
MODERN 3



MODEL:
MODERN 4 -2iO



MODEL:
MODERN 4 -2NO



MODEL:
MODERN 4 -4i0



MODEL:
MODERN 4



MODEL:
MODERN 4A

MODELE



NOTĂ: Toate modelele din gama MODERN se pot realiza și în varianta filo-pervaz (FP)



gama
MODERN





gama **STYLE**

Gama Style a ușilor de interior se adaptează perfect unui ambient personalizat, calitatea ridicată a finisajului și a materialelor fiind puse în valoare de designul original. Style, cum și numele sugerează, este ceea ce rezultă din întâlnirea clasicului cu inovațiile de azi.

Gama STYLE - DESCRIERE

■ FOAIE DE UȘĂ - grosime 44 mm - este construită din lemn lamelar de rășinoase și PAL plus lemn (în cazul traverselor), placat la exterior cu MDF grosime 4 mm furniruit cu furnir din lemn natural de stejar în cazul culorilor băițuite. În cazul vopsirii în culori RAL por deschis ușile vor fi furniruite cu furnir din lemn natural de frasin. În cazul vopsirii în culori RAL por închis vopsirea se realizează direct pe suprafața de MDF a ușii.

- Tăblii - sunt construite din MDF grosime totală 20 mm furniruit cu furnir din lemn natural, după caz.

În cazul modelelor de uși echipate cu sticlă cu model sau transparentă aceasta este protejată cu folie de siguranță.

- Baghete de susținere a tăbliilor sau sticlei - sunt construite din lemn masiv îmbinat în dinți furniruit cu furnir din lemn natural, după caz.

Modelele de baghetă Baroc sunt din lemn masiv de stejar.

■ TOC - (40 mm grosime / 100 mm lățime) construit din panel lemn stratificat rășinos (5 straturi) furniruit cu furnir din lemn natural (după caz).

Tocurile sunt echipate cu garnituri de etanșare (albe sau maro, după caz).

■ PERVAZURI reglabile - construite din lemn multistrat / MDF / MDF bipres furniruite cu furnir din lemn natural (după caz).

■ CĂPTUȘELI reglabile - construite din MDF grosime 10 mm x lățime (după caz) furniruit cu furnir din lemn natural (după caz).

57TH
STREET
BROOKLYN
CONEY ISLAND
TIMES SQUARE
GRAND CENTRAL
HARLEM

NY
BROADWAY
W34ST
CENTRAL
PARK
WEST



MODEL:
STYLE 01

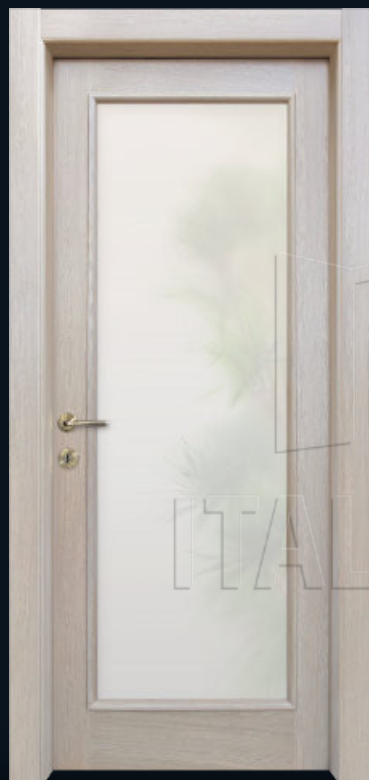

MODEL:
STYLE 01A



MODEL:
STYLE 03

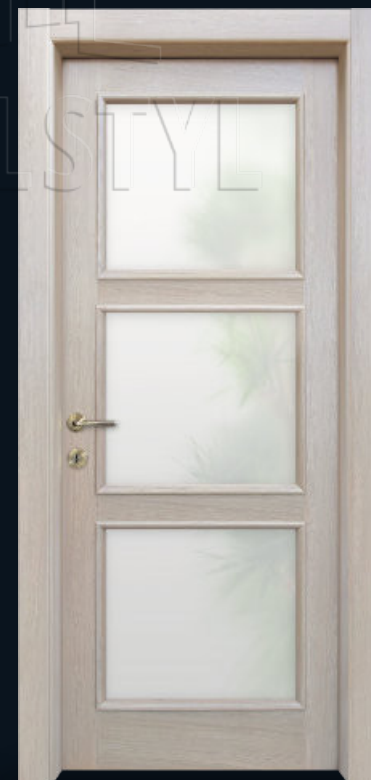

MODEL:
STYLE 03A



MODEL:
STYLE 02A



MODEL:
STYLE 02



MODEL:
STYLE 02C



MODEL:
STYLE 07



MODEL:
STYLE 07A



MODEL:
STYLE 02A

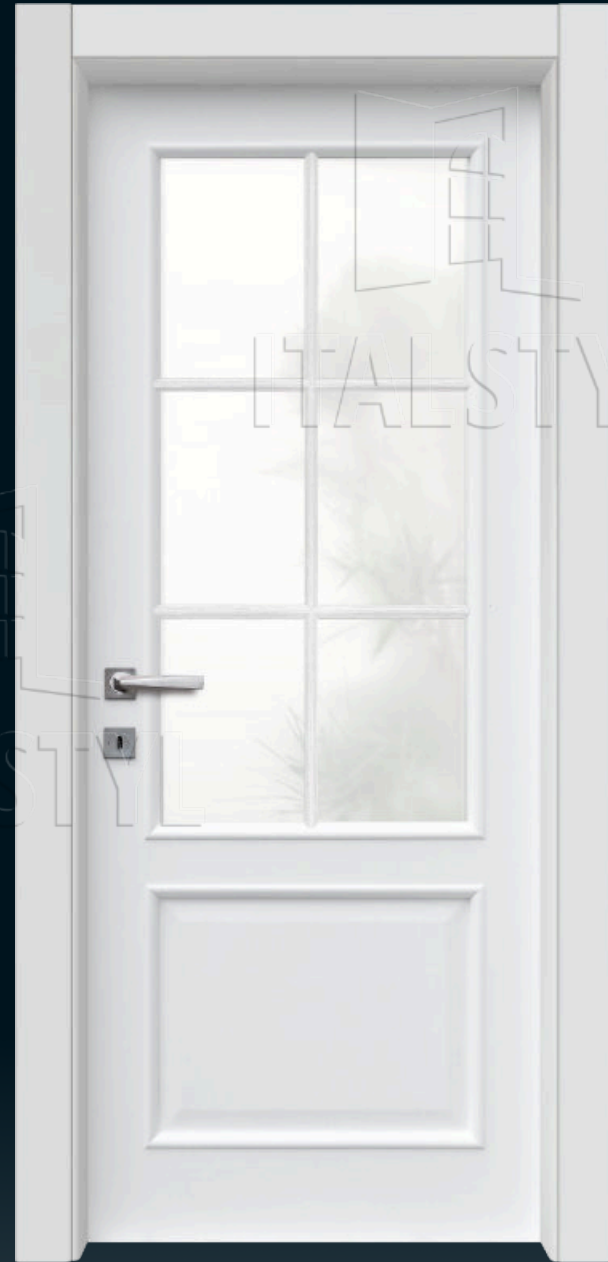

MODEL:
STYLE 02C

STYLE CLASSY
CU PERVAZE DECO
ȘI CAPITEL



ITALSTYL

MODEL:
STYLE 01R





ITALSTYL

ITALSTYL

ITALSTYL

MODELE

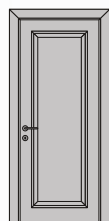

Style 01

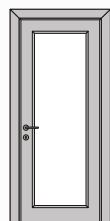

Style 01A

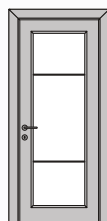

Style 01-1A

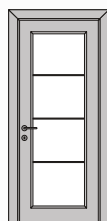

Style 01-2A



Style 01B



Style 01C

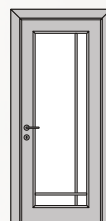

Style 01D



Style 01R



Style 02



Style 02T



Style 02A

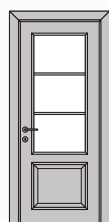

Style 02B

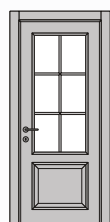

Style 02C



Style 02D



Style 03

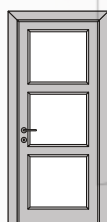

Style 03A



Style 04

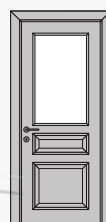

Style 04A



Style 05



Style 05A



Style 06

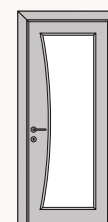

Style 06A

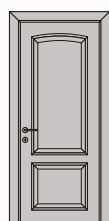

Style 07



Style 07A



Style 08

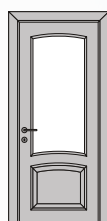

Style 08A

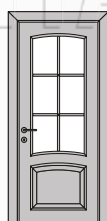

Style 08B



Style 11

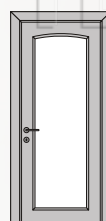

Style 11A

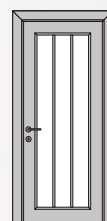

Style 11E



Style 12



Style 12A

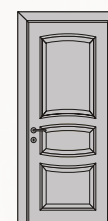

Style 14

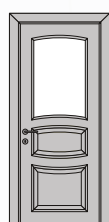

Style 14A



Style 15



Style 15A



Style 18

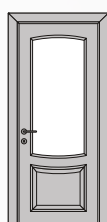

Style 18A

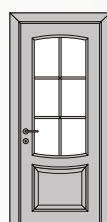

Style 18B

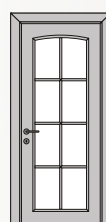

Style 18C



Style R-0A

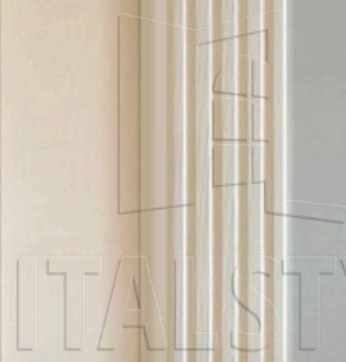

gama
STYLE



gama **BAROC**

Ușile de interior din Gama Baroc sunt concepute pentru a fi integrate în amenajări interioare de inspirație clasică. Ușile din această gamă sunt o categorie aparte, remarcându-se prin finisajul de înaltă calitate, dar au și o durată mare de folosință, dată de rezistența în timp a materialelor și finisajelor, calități specifice produselor premium.

Gama BAROC - DESCRIERE

■ FOAIE DE UȘĂ - grosime 44 mm - este construită din lemn lamelar de rășinoase și PAL plus lemn (în cazul traverselor), placat la exterior cu MDF grosime 4 mm furniruit cu furnir din lemn natural de stejar în cazul culorilor băițuite.

În cazul vopsirii în culori RAL por deschis ușile vor fi furniruite cu furnir din lemn natural de frasin.

În cazul vopsirii în culori RAL por închis vopsirea se realizează direct pe suprafața de MDF a ușii.

- Tăblii - sunt construite din MDF grosime totală 20 mm furniruit cu furnir din lemn natural, după caz.

În cazul modelelor de uși echipate cu sticlă (cu model sau transparentă) aceasta este protejată cu folie de siguranță.

- Baghete de susținere a tăbliilor sau sticlei - sunt construite din lemn masiv de stejar.

■ TOC - (40 mm grosime / 100 mm lățime) - construit din panel lemn stratificat rășinos (5 straturi) furniruit cu furnir din lemn natural (după caz).

Tocurile sunt echipate cu garnituri de etanșare (albe sau maro, după caz).

■ PERVAZURI reglabile - construite din lemn multistrat / MDF / MDF bipres furniruite cu furnir din lemn natural (după caz).

■ CĂPTUȘELI reglabile - construite din MDF grosime 10 mm x lățime (după caz) furniruit cu furnir din lemn natural (după caz).



ITALSTYL

Leamă prin excelență



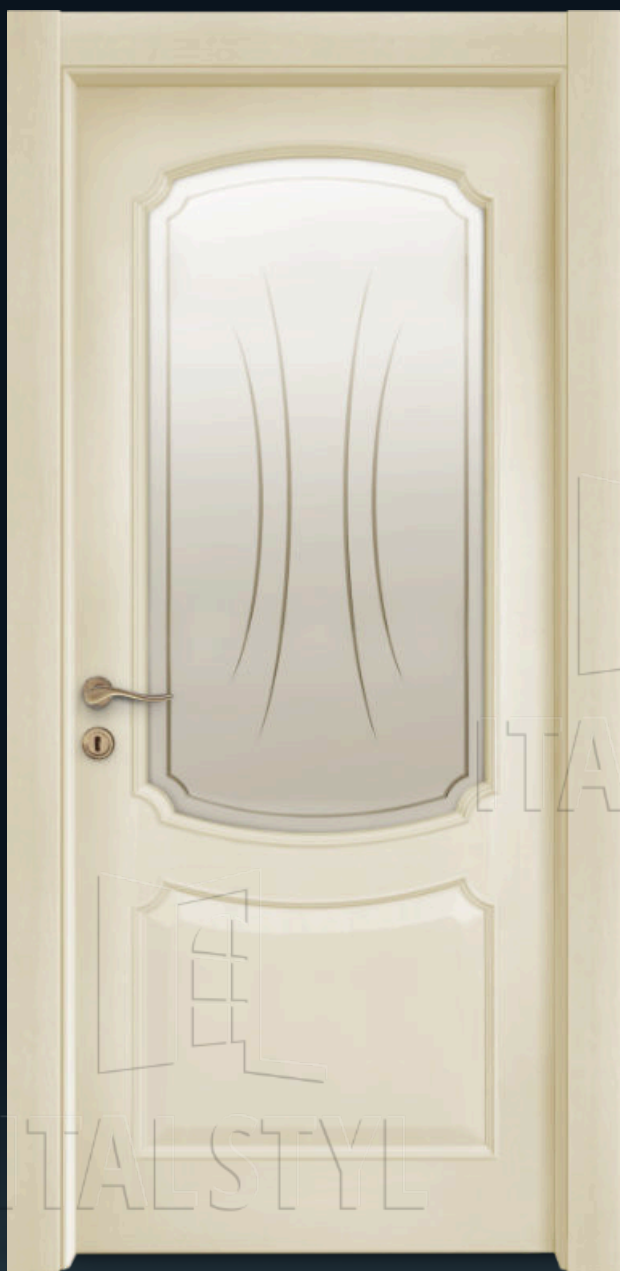

MODEL:
BAROC 03A



MODEL:
BAROC 03D



MODEL:
BAROC 03B



MODEL:
BAROC 03E



MODEL:
BAROC 01



MODEL:
BAROC 01A



MODEL:
BAROC 01F



MODEL:
BAROC 01G



MODEL:
BAROC 01B



MODEL:
BAROC 01E



MODEL:
BAROC 02H



MODEL:
BAROC 03A



MODEL:
BAROC 02



MODEL:
BAROC 02A



MODEL:
BAROC 02C



MODEL:
BAROC 02D

MODELE

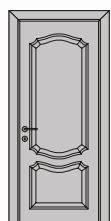

Baroc 01

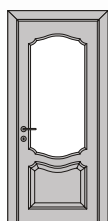

Baroc 01A

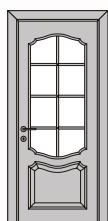

Baroc 01B

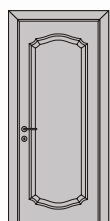

Baroc 01C



Baroc 01D



Baroc 01E



Baroc 01F

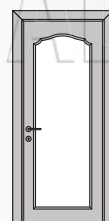

Baroc 01G



Baroc 01H

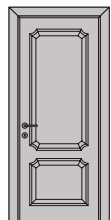

Baroc 02

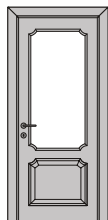

Baroc 02A

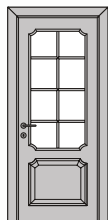

Baroc 02B



Baroc 02C



Baroc 02D



Baroc 02E

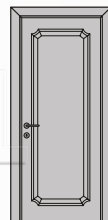

Baroc 02F

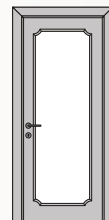

Baroc 02G

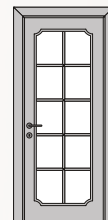

Baroc 02H

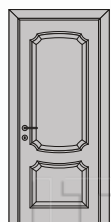

Baroc 03

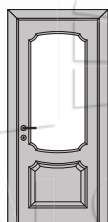

Baroc 03A

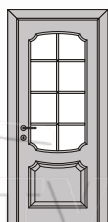

Baroc 03B

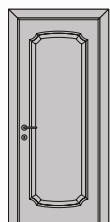

Baroc 03C

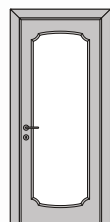

Baroc 03D



Baroc 03E



Baroc 03F

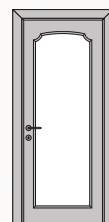

Baroc 03G

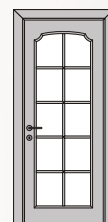

Baroc 03H

gama

BAROC



gama
SARA

Ușile de interior din gama Sara sunt alegerea perfectă pentru întregirea cu succes a unui ambient personalizat, fie el modern sau clasic. Soluțiile de design și calitatea remarcabilă a produsului finit sunt argumente care recomandă ușile din această categorie.

Gama SARA - DESCRIERE

■ FOAIE DE UȘĂ - grosime 44 mm - este construită dintr-un cadru de panel lemn stratificat (5 straturi) furniruit cu furnir din lemn natural stejar în cazul culorilor băițuite. În cazul vopsirii în culori RAL por închis furniruirea se realizează cu furnir de lemn natural tanganica.

- Tăblieri profilate - sunt construite din MDF grosime totală 20 mm furniruit cu furnir din lemn natural, după caz.

- Tăblieri drepte - sunt constituite din MDF grosime totală 18 mm.

În cazul modelelor de uși echipate cu sticlă (cu model sau transparentă) aceasta este protejată cu folie de siguranță.

■ TOC - (40 mm grosime / 100 mm lățime) - construit din panel lemn stratificat rășinos (5 straturi) furniruit cu furnir din lemn natural (după caz).

Tocurile sunt echipate cu garnituri de etanșare (albe sau maro, după caz).

■ PERVAZURI reglabile - construite din lemn multistrat / MDF / MDF bipres furniruite cu furnir din lemn natural (după caz).

■ CĂPTUȘELI reglabile - construite din MDF grosime 10 mm x lățime (după caz) furniruit cu furnir din lemn natural (după caz).





MODEL:
SARA 1A



MODEL:
SARA 1B



MODEL:
SARA 3D



MODEL:
SARA 1E



MODEL:
SARA 3E



MODEL:
SARA 04



MODEL:
SARA 04



MODEL:
SARA 04

MODELE

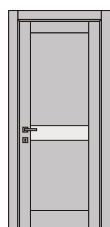

Sara 1

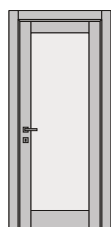

Sara 1A

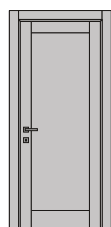

Sara 1B

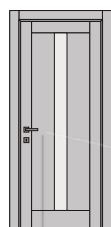

Sara 1C



Sara 1E



Sara 3D



Sara 3E

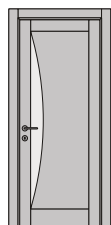

Sara 4R



Sara 110



Sara 210



Sara 04

gama
SARA



gama
GRAF

Ușile de interior din gama Graf se adaptează perfect unui ambient nonconformist, remarcându-se prin calitatea ridicată a finisajelor și prin designul deosebit. Ușile pantografate pot avea o paletă largă de modele și în afara celor prezentate aici.

Gama GRAF - DESCRIERE

■ FOAIE DE UȘĂ - grosime 44 mm - este construită dintr-un cadru din lemn masiv rășinos îmbinat în dinți sau (amestec rășinos plus foioase), cu interior din structură celulară (carton celular ceruit care conferă stabilitate și determină reducerea greutateii foii de ușă) placată la exterior cu MDF grosime 8 mm. La seria ușilor cu pantografieri ușoare (gama Graf-Linea) MDF-ul este de 4 mm.

În cazul vopsirii în culori RAL por deschis (la cerere) se vor furniza cu furnir din lemn natural de frasin pe suprafețele lise, iar pe zona de profil se va vopsi direct pe suprafața de MDF (por închis).

■ TOC - (40 mm grosime / 100 mm lățime) - construit din panel lemn stratificat rășinos (5 straturi) furnizit cu furnir din lemn natural (după caz).

Tocurile sunt echipate cu garnituri de etanșare (albe sau maro, după caz).

■ PERVAZURI reglabile - construite din lemn multistrat / MDF / MDF bipres furnizite cu furnir din lemn natural (după caz).

■ CĂPTUȘELI reglabile - construite din MDF grosime 10 mm x lățime (după caz) furnizit cu furnir din lemn natural (după caz).



ITALSTYL



ITALSTYL



ITALSTYL



MODEL:
GRAF A2



MODEL:
GRAF A3





MODEL:
GRAF A1



MODEL:
GRAF A2
TIP PERVAZ PS-03





MODEL:
GRAF SQ



MODEL:
GRAF LINEA M1





MODEL:
GRAF LINEA Q1



MODEL:
GRAF LINEA M10



MODEL:
GRAF 3D



MODEL:
GRAF LINEA M11

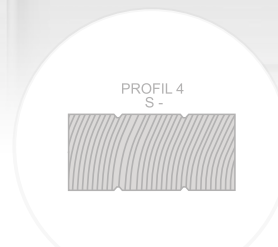



MODEL:
GRAF LINEA M5

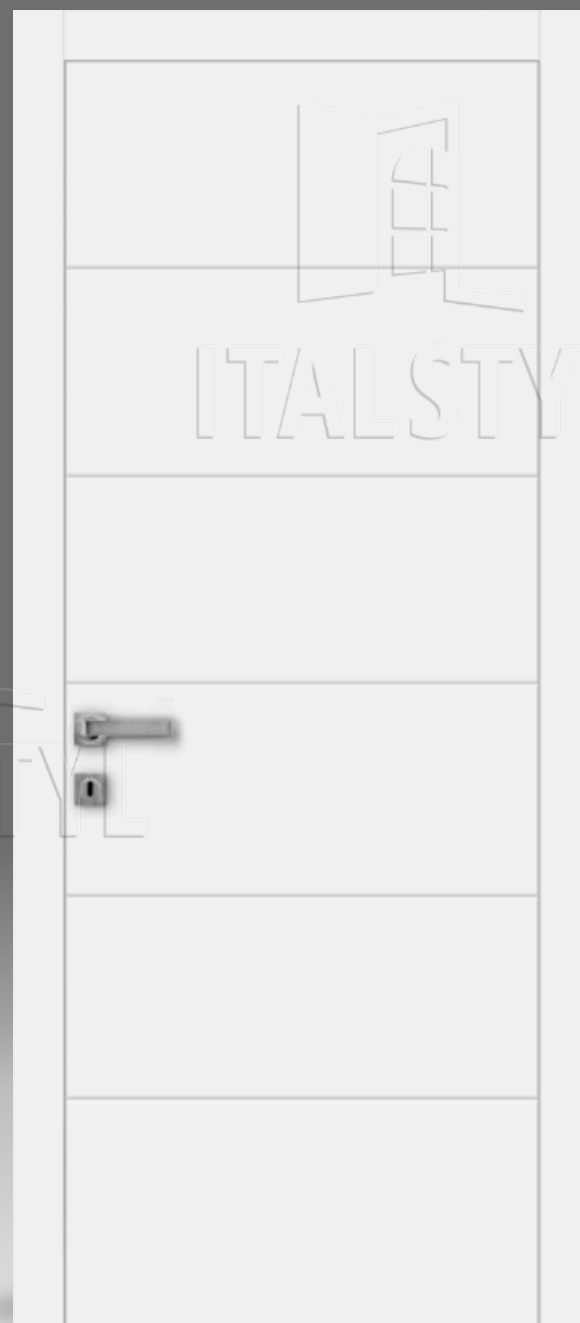

MODEL:
GRAF 5NO-FP



MODEL:
GRAF 8S



MODEL:
GRAF LINEA C2

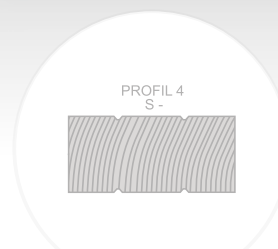



MODEL:
GRAF 2NV



MODEL:
GRAF LINEA M7

GRAF CLASSY
CU PERVAZE DECO



TIP PERVAZ
PS-04



GRAF CLASSICO
CU PERVAZE DECO
ȘI CAPITEL

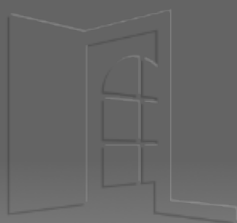

MODEL:
GRAF A2

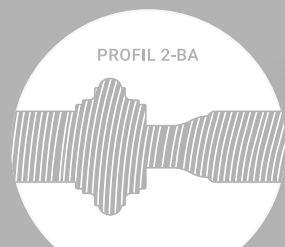

TIP CAPITEL
C-01B

TIP PERVAZ
PS-01/02



MODELE

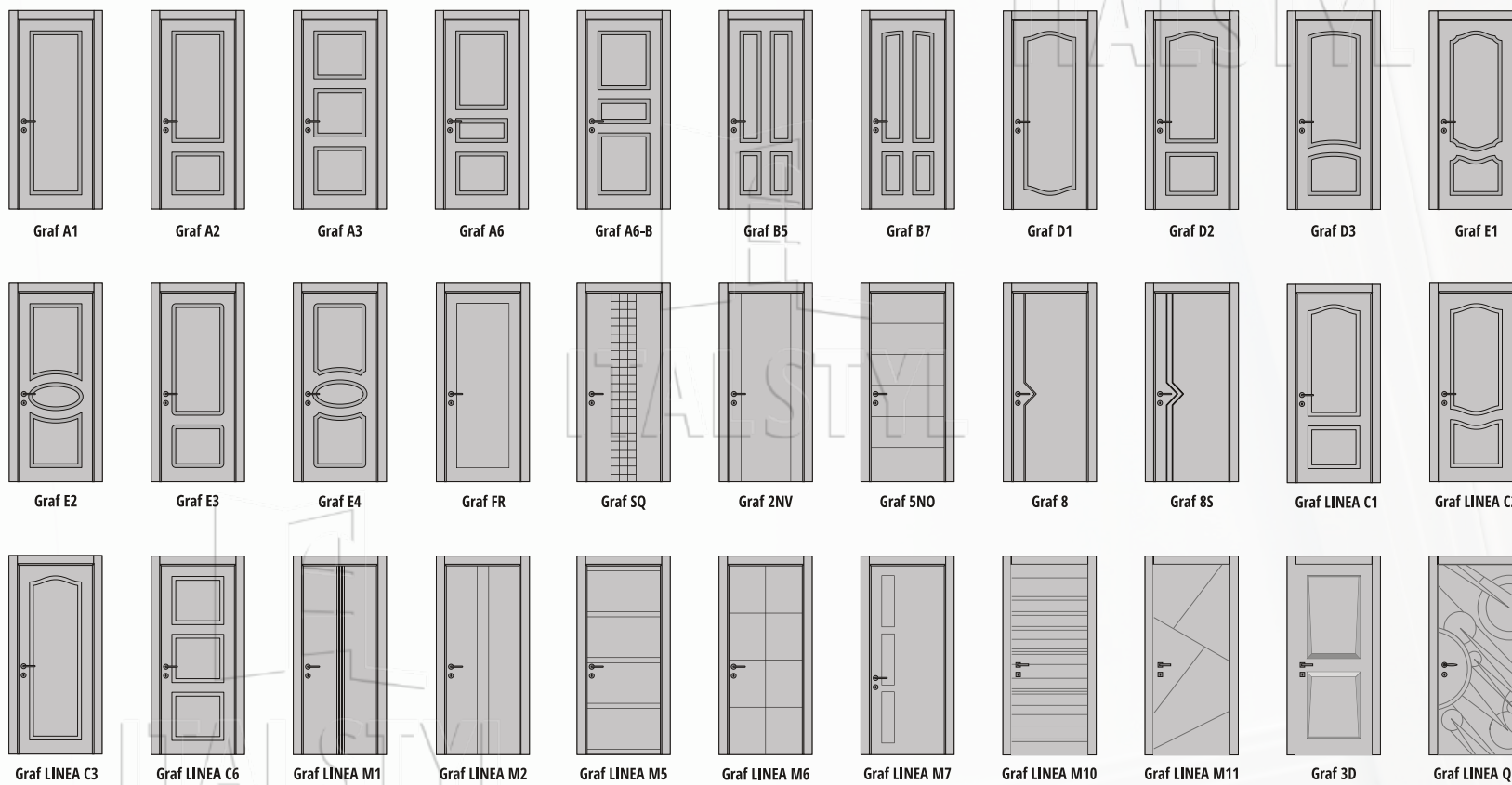

NOTĂ: Toate modelele din gama GRAF se pot realiza și în varianta filo-pervaz (FP)

gama
GRAF

PROFILE
Graf

PROFIL 1



PROFIL 2



PROFIL 3



PROFIL 4
S-



PROFIL 5
S+ / S-



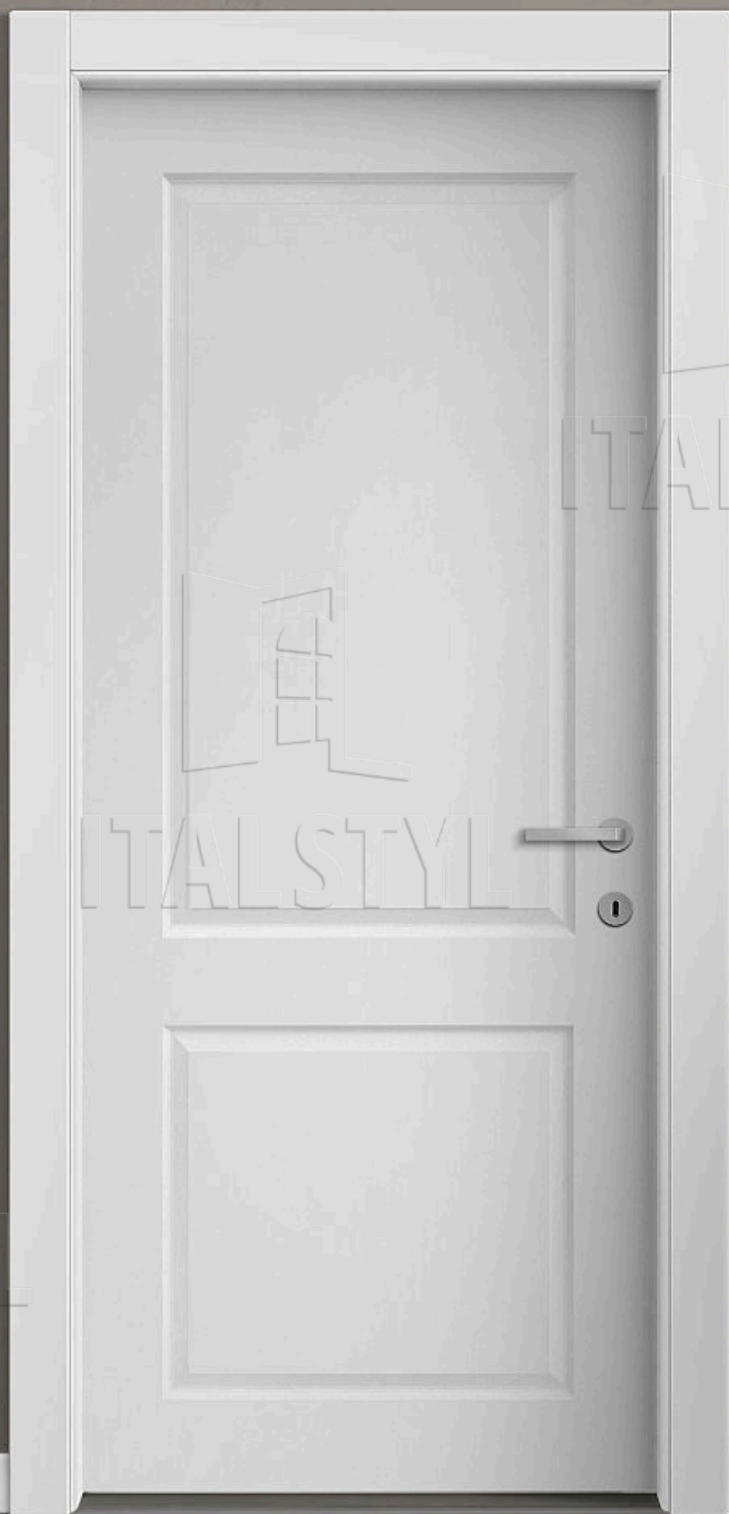

gama **E-LINE**

Ușile de interior din gama E-line sunt o apariție nouă în portofoliul Ital Styl, o nouă abordare, consecință a provocărilor permanente ale prezentului. "E-line" este materializarea unui concept de fabricație inovativ care se adresează în special tinerilor, caracteristica definitorie a acestor uși fiind adaptabilitatea. Pot fi soluția ideală pentru un ambient modern, minimalist, în care notele dominante sunt confortul și energia pozitivă.

Gama E-LINE - DESCRIERE

■ **FOAIE DE UȘĂ** - grosime 44 mm - este construită dintr-un cadru din lemn masiv rășinos îmbinat în dinți sau (amestec rășinos plus foioase), cu interior din structură celulară (carton celular ceruit care conferă stabilitate și determină reducerea greutății foii de ușă) placată la exterior cu HDF grosime 3 mm.

Vopsirea (culori RAL) se realizează direct pe suprafața de HDF a ușii.

■ **TOC** (40 mm grosime / 100 mm lățime) - construit din panel lemn stratificat rășinos (5 straturi) furniruit cu furnir din lemn natural (după caz). Tocurile sunt echipate cu garnituri de etanșare (albe sau maro, după caz).

■ **PERVAZURI** reglabile 70 mm / 90 mm - construite din MDF.

■ **CĂPTUȘELI** reglabile - construite din MDF grosime 10 mm x lățime (după caz).





MODEL:
E-1



MODEL:
E-2

MODELE

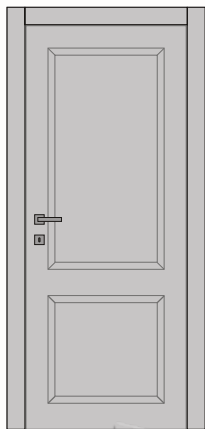

E1

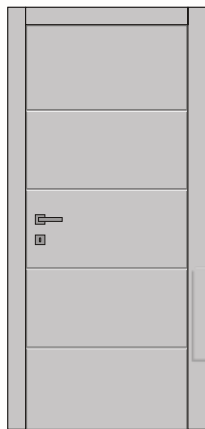

E2



gama Nou! E-LINE



Toc de trecere

Tocul de trecere este o soluție ideală pentru optimizarea spațiilor interioare deschise. Tocurile de trecere din lemn sunt importante și pentru faptul că sunt elemente de design interior care conferă eleganță casei. Open space este un concept ce a fost adoptat și la noi în ultima perioadă, odată cu noile sisteme performante de încălzire prin pardoseală, ce sunt de obicei preferate și recomandate. Casele cu sisteme de încălzire revoluționare bazate pe energia verde au în general sisteme de încălzire prin pardoseală, pentru care Ital Styl oferă pardoseli speciale.



Exemple de tocuri de trecere



Pervaze speciale și capiteluri

LA MODELE SPECIALE

ÎN STIL CLASIC

Ușilor de interior li se pot adăuga elemente decorative sub forma capitelurilor și a pervazelor decorate, rezultând modele aparte, ce definesc spațiile din punct de vedere al design-ului, în special în interioarele de inspirație clasică.

Puteți opta pentru aceste elemente în completarea foilor de ușă pantografate sau a ușilor cu sticlă ce poate fi decorată cu șproșuri, simplă, sablată sau cu vitralii.

TIPURI DE PERVAZE SPECIALE ȘI CAPITELUȚI

- PERVAZE SPECIALE reglabile - construite din lemn multistrat / MDF / MDF bipres furniruite cu furnir din lemn natural (după caz).
- Capiteluri - construite din lemn multistrat / MDF / MDF bipres furniruite cu furnir din lemn natural (după caz).



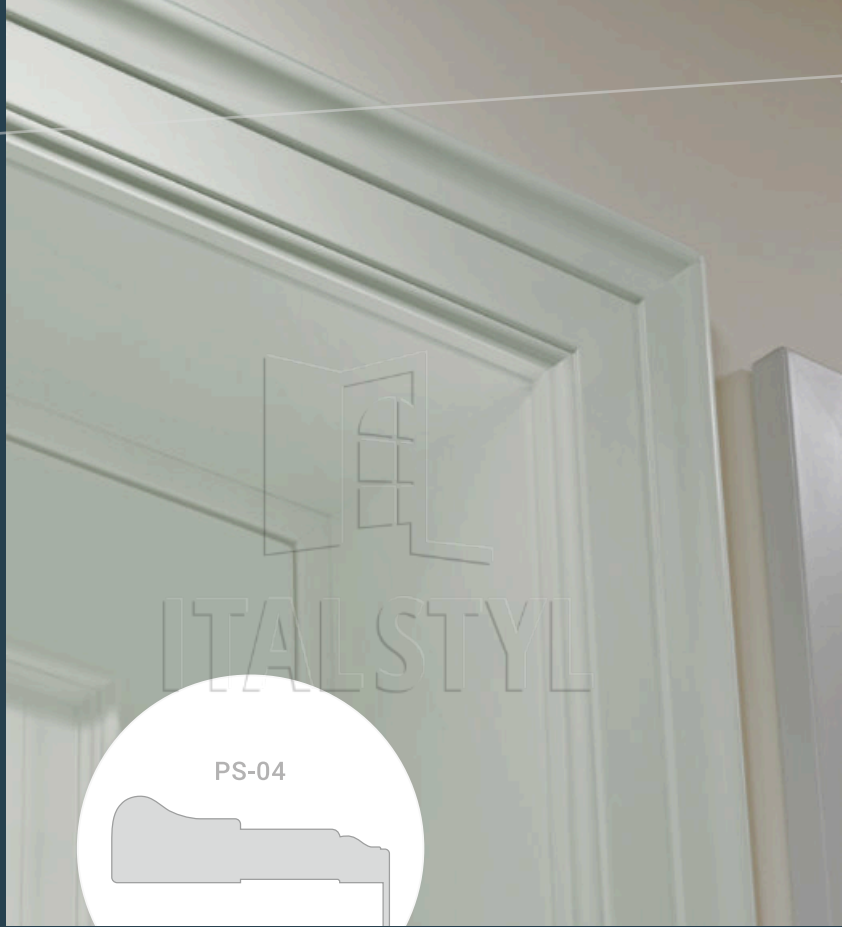
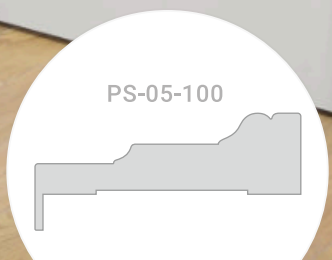

Modele pervaze speciale



PS-03





Exemple capiteluri

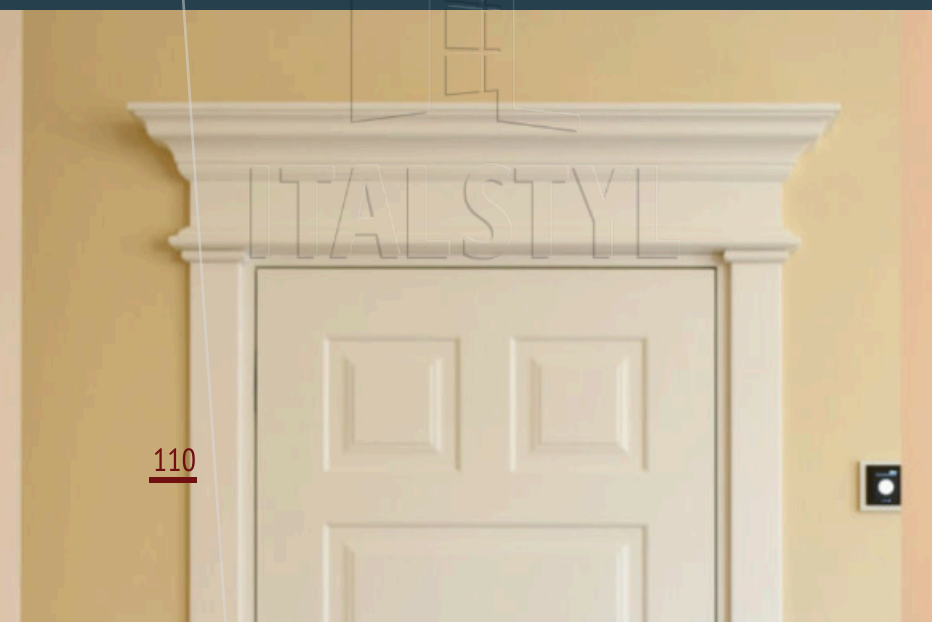



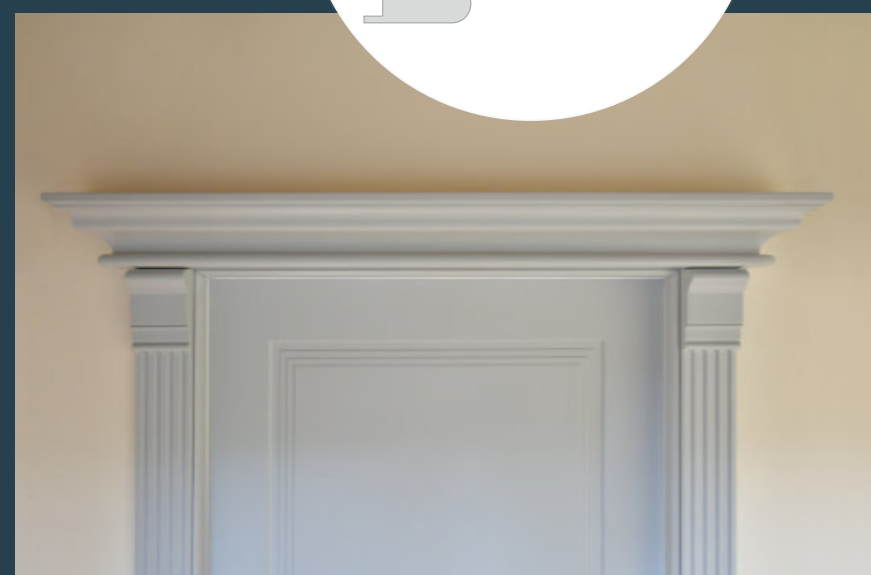

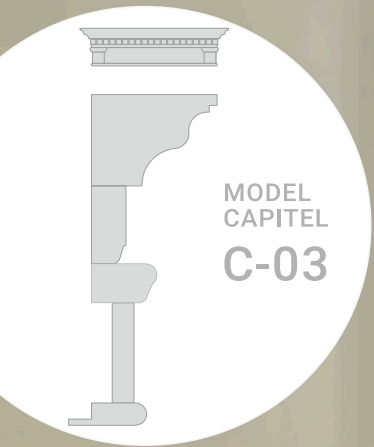

MODEL
CAPITEL
C-03





Uși de interior pentru **HOTELURI și PENSIUNI**

O noutate în portofoliul Ital Styl: uși special concepute pentru hoteluri sau pensiuni. Acestea sunt uși special adaptate noilor sisteme de control acces hotelier cu închidere electromagnetică, prin intermediul cardurilor de proximitate.

Uși de interior speciale
pentru hoteluri și pensiuni



MODEL:
STYLE 11E*

*model adaptat



ITALSTYL

Leamă prin excelență



MODEL:
MODERN 1 AV



Uși de interior speciale pentru hoteluri și pensiuni



MODEL:
MODERN 1FN





**Uși de interior speciale
pentru hoteluri și pensiuni**

MODEL:

MODERN 1-1SV

ACCESORII HOTELURI: ÎNCHIDERE
ELECTROMAGNETICĂ

 ITALSTYL

Uși interior

MODEL:
GRAF A2
PROFIL 2



Uși de interior speciale
pentru hoteluri și pensiuni



MODEL:
GRAF A2



**Sisteme de control acces
cu carduri de proximitate**

FINISAJE STANDARD

STEJAR NATUR
LAC

CASTAN 10

TEAK 8

ROVERE 10

Culori BAIȚ / LAC / RAL

Culori baie standard: gama prezentată aici.
Culori RAL standard: RAL 9003, RAL 1013.
Alte culori RAL - la cerere.

ROVERE 6

CASTAN 1-8

MAHON 1-6

ROVERE 1-8

FINISAJE STANDARD

ROVERE 1-6

ROVERE N-S

WENGE 6

NERO

EXONERARE

Culorile, texturile și finisajele prezentate au rol orientativ și pot varia față de mostrele reale. Pentru a face o alegere a finisajului viitoarelor uși de interior, vă rugăm să solicitați și să vizualizați o mostră reală.

RAL 9003

POR DESCHIS

RAL 9003

POR ÎNCHIS

RAL 1013

POR DESCHIS

RAL 1013

POR ÎNCHIS

TIPURI DE PROFILE PENTRU UȘI INTERIOR FURNIRUITE TOCURI - CĂPTUȘELI - PERVAZE

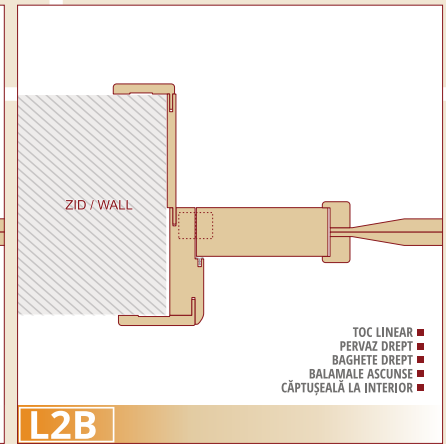
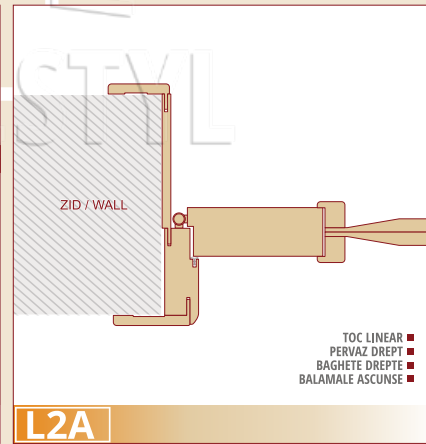
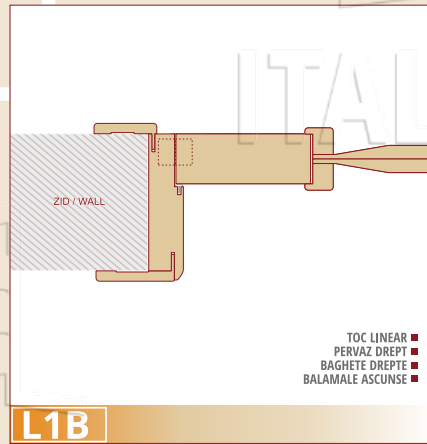
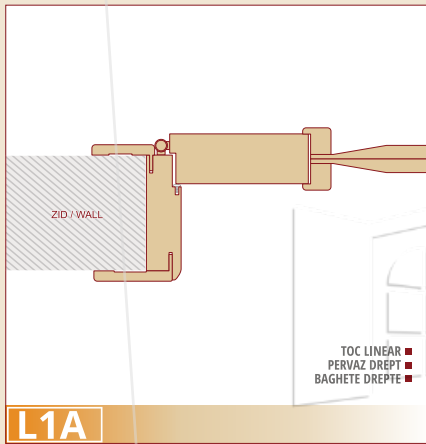
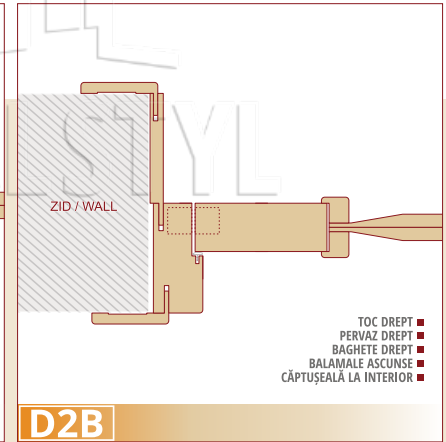
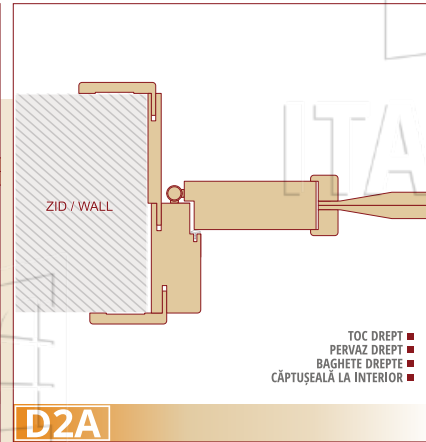
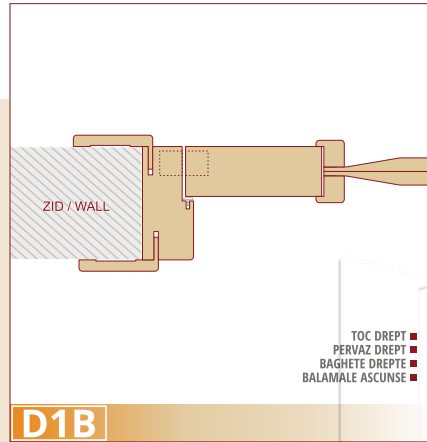
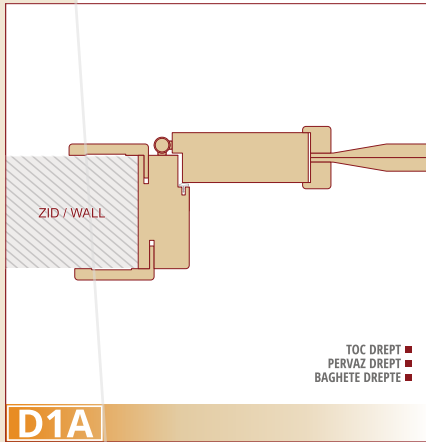

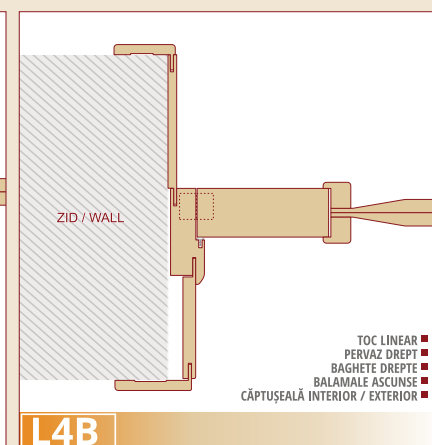
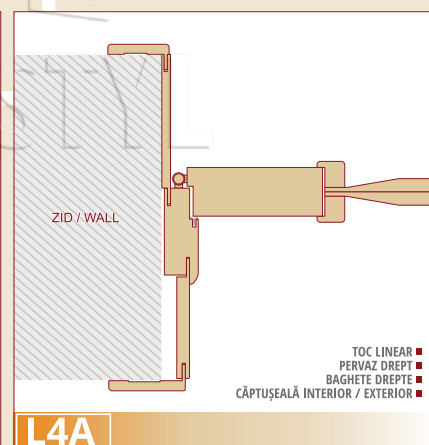
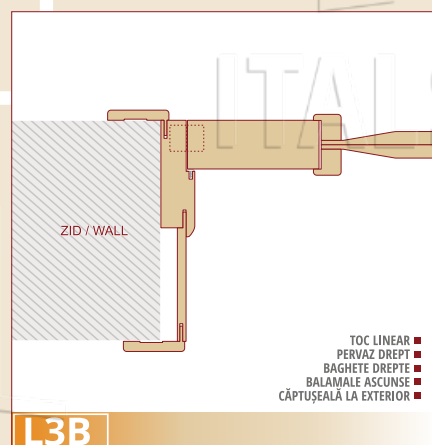
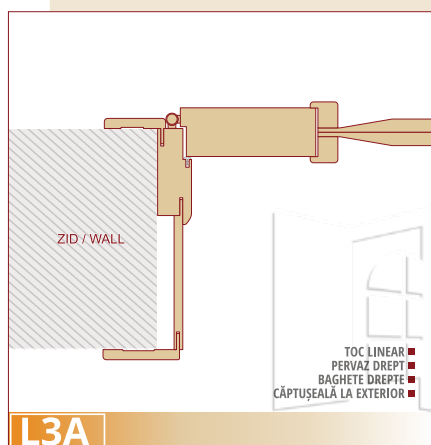
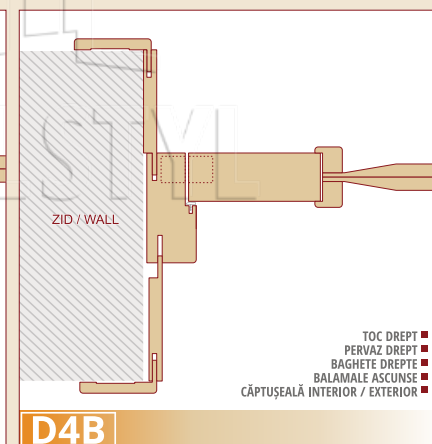
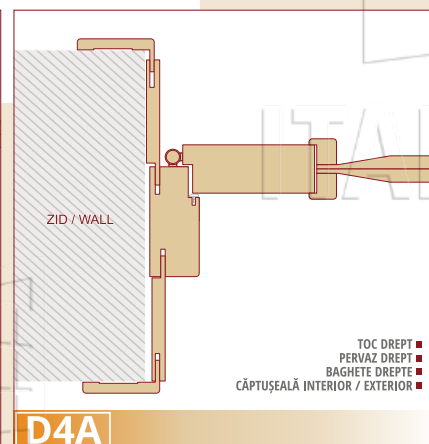
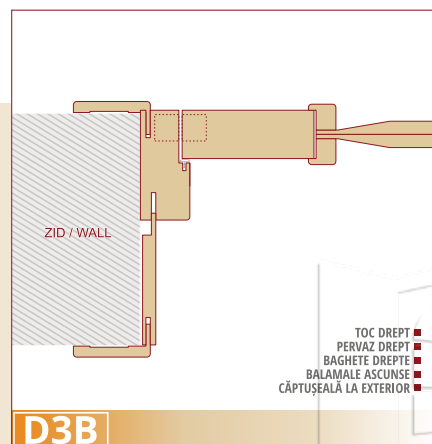
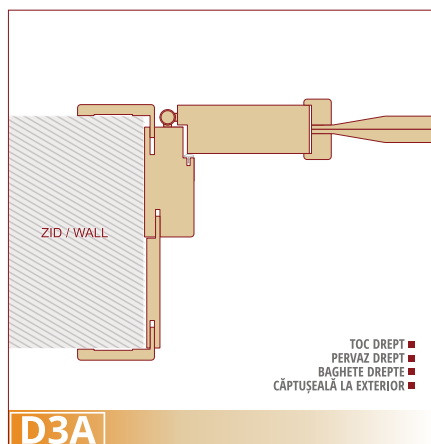

Din ce sunt fabricate ușile?

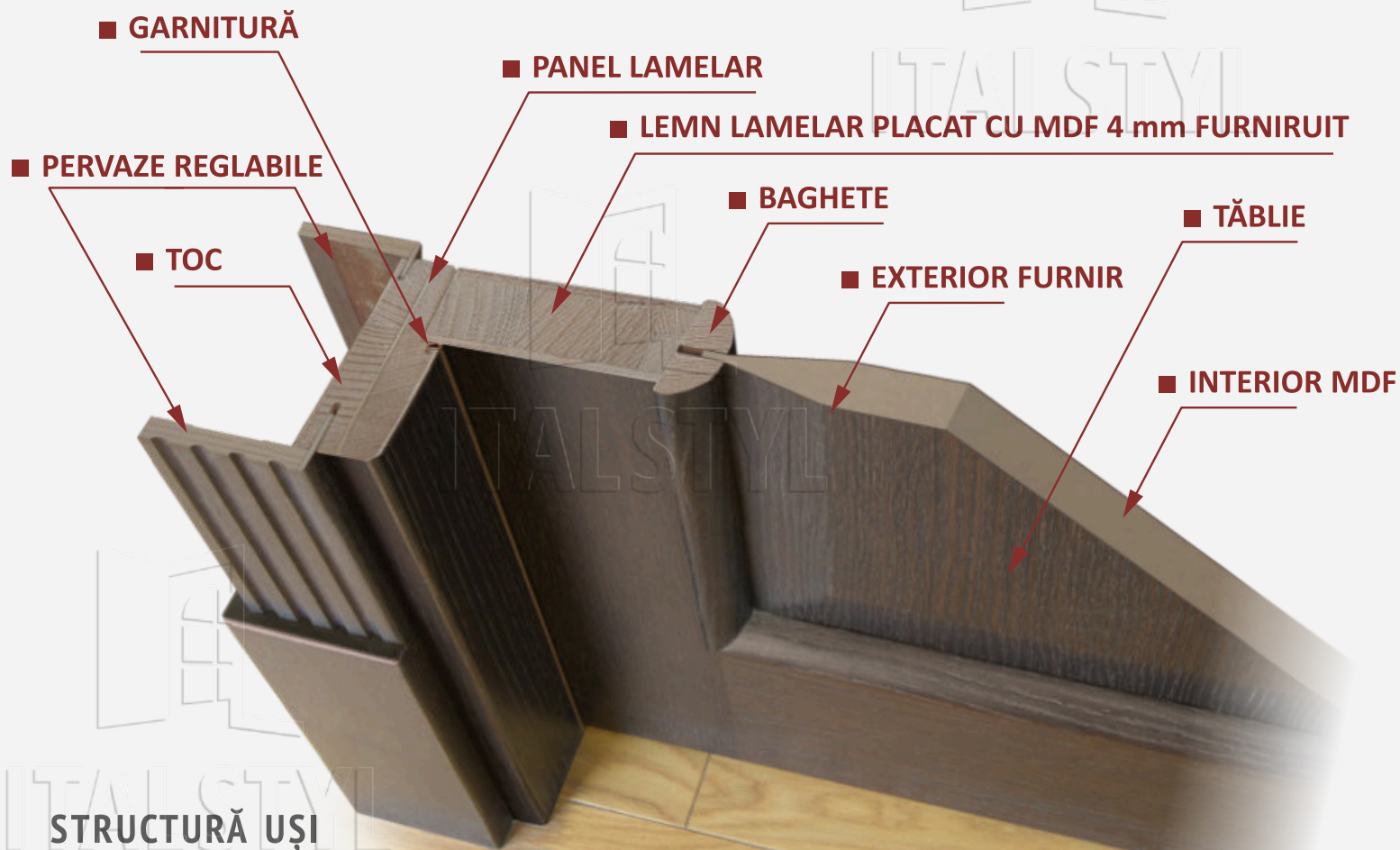

STRUCTURĂ UȘI

- **STYLE**
- **BAROC**
- **SARA (FĂRĂ BAGHETE)**

■ Structură plină
(PAL plin)

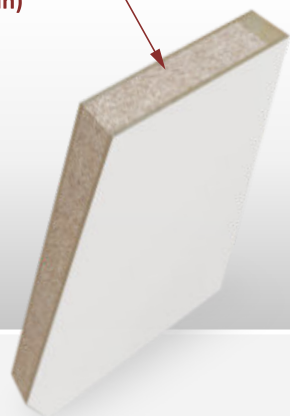

■ Structură plină perforată
(PAL tubular)



■ Structură celulară de stabilizare
(tip fagure)



■ **VARIANTE INTERIOR FOAIE UȘĂ**

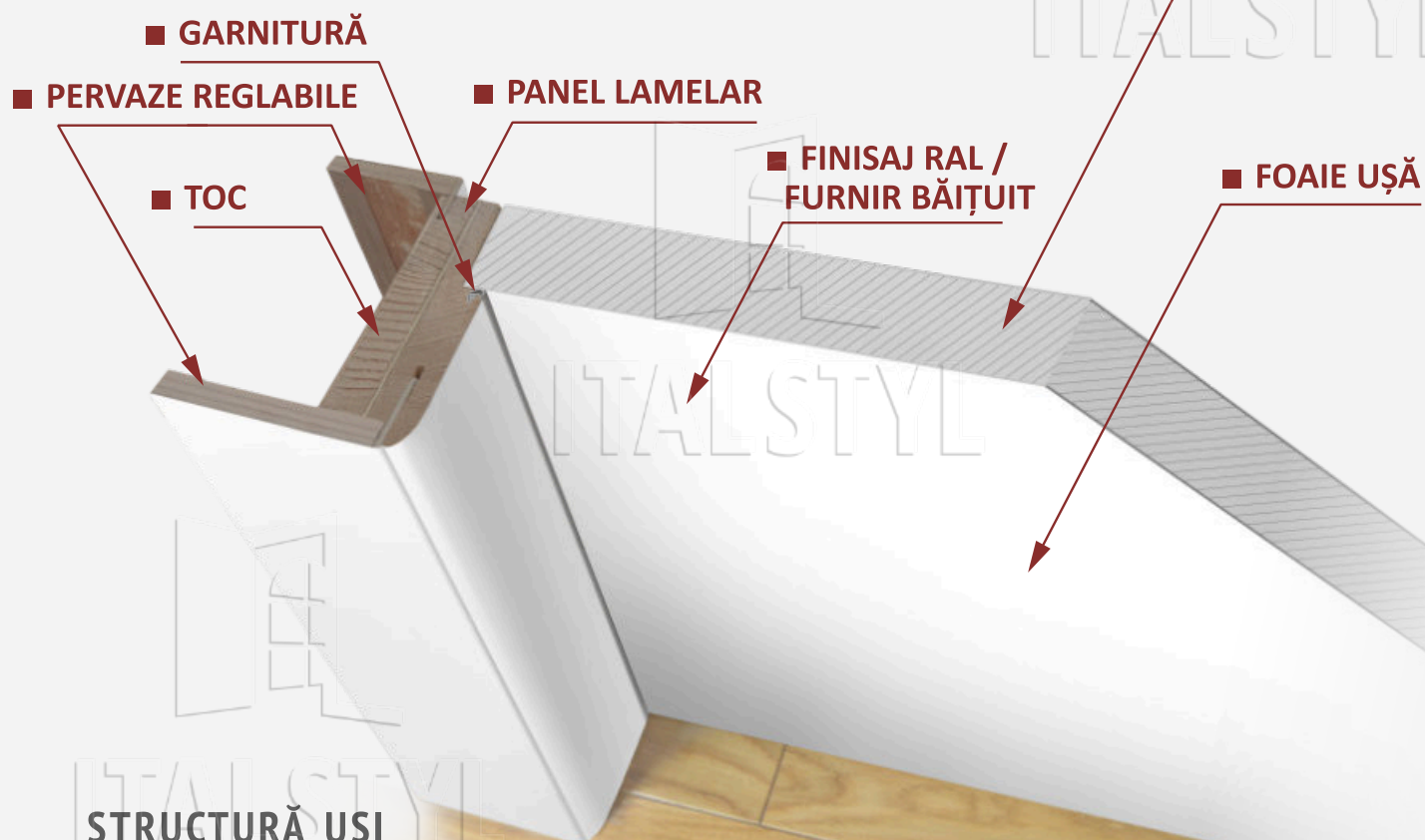

STRUCTURĂ UȘI

- MODERN
- GRAF
- E-LINE



Accesorii

■ Mânere uși

Oferim o gamă largă de mânere de calitate premium de la diverse companii de renume, pentru a asigura ușilor dumneavoastră un aspect estetic plăcut, dar mai ales funcționalitatea optimă și o durată de folosință cât mai îndelungată.



■ Broască magnetică

În momentul în care se închide ușa, mânerul trebuie acționat, limba magnetică a broăștei rămânând în interior. Este asigurată liniștea maximă în momentul în care se închide ușa datorită mecanismului compact. Se poate utiliza pe închidere în ambele sensuri, fără să se inverseze bolțul. Placa din față nu are limba la broască ieșită în exterior: limba magnetică a broăștei este retrasă în interior în momentul în care ușa este deschisă și iese în afară doar în momentul în care ușa se închide. Performanță ridicată într-un spațiu restrâns:

- Timp redus de producție
- Inovare tehnică
- Inovare estetică



■ Broască silențioasă

Limba broăștei silențioasă: inserția celor două elemente în material rezistent la șocuri (nylon - poliamidă) permite minimizarea zgomotului produs în mod obișnuit de acționarea broăștei. Silențiozitate maximă în mână și în carcasă datorată construcției compacte a mecanismului. Limba broăștei se blochează lăsând liberă rotația mânerului. Deschiderea ușii și revenirea limbii în poziția închis se realizează prin rotirea cheii.

Performanță ridicată într-un spațiu restrâns:

- Timp redus de producție
- Inovare tehnică
- Inovare estetică

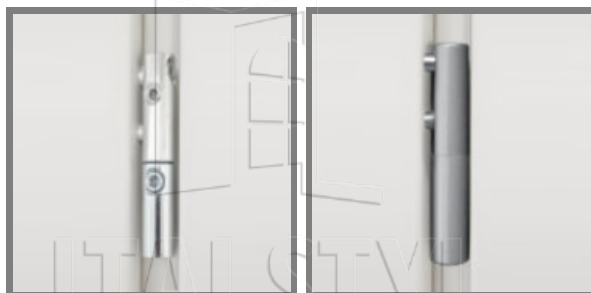

■ Balamale aparente

Balamalele aparente intră în echiparea standard a ușilor noastre. Capacele acestor balamale pot avea finisaje în acord cu celelalte accesorii și cu finisajul ușii, respectiv argintiu, auriu, bronz.



■ Balamale ascunse

Balamalele ascunse sunt preferate pentru un design în care aspectul foii de ușă nu este în niciun fel alterat de prezența balamalelor, oferind astfel un plus de eleganță și simplitate ușii.

Uși glisante

Ușa care culisează nu este doar o ușă glisantă, ci, după atente cercetări și perfecționări tehnice, a devenit un sistem original și complex, capabil să satisfacă toate aplicațiile golurilor de ușă, de la deschideri minime (60 cm) la spații mari (pană la 470 cm) indiferent de construcția peretelui (gips-carton sau zidărie). Aceasta presupune că sistemul poate fi utilizat și pentru goluri de ușă cu lățimi de 102 cm. În funcție de necesități, două camere de mărimi medii pot fi unite printr-o deschidere amplă și transformate într-un ambient unic, cu spațiu generos.

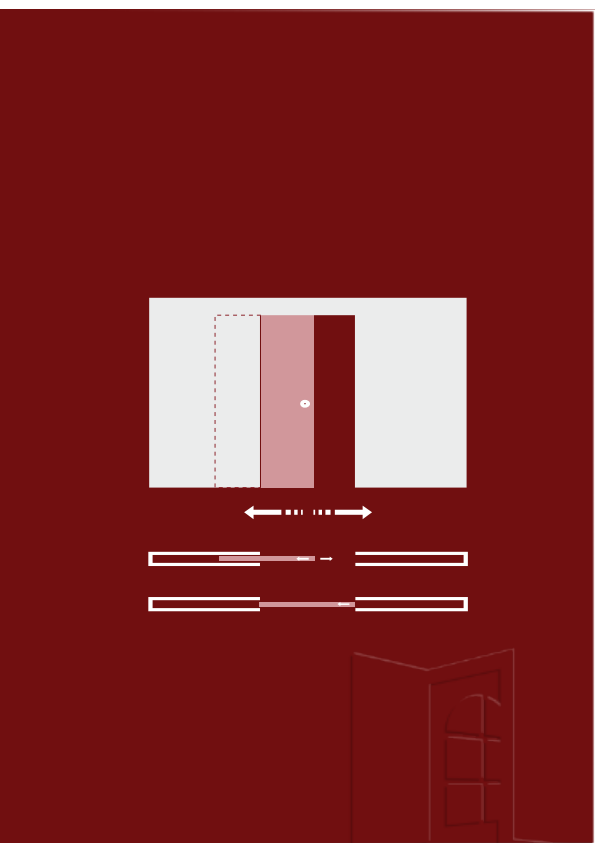

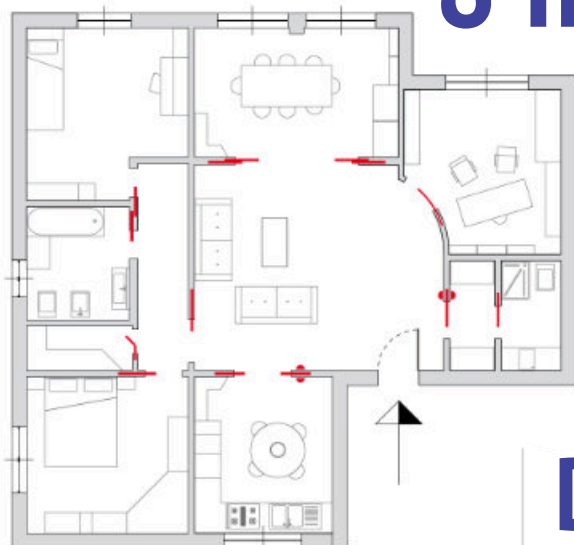
Spațiu recuperat: **8 m²**

Avantaje:

- Deschidere amplă și acces generos;
- Suprafețe utile extinse;
- Spațiile înguste devin funcționale.

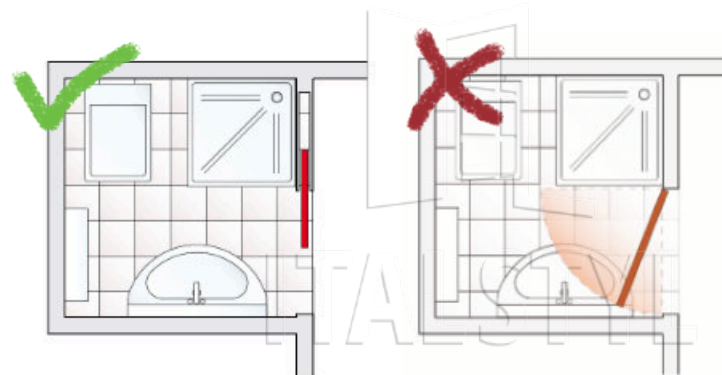

Dacă ușa este glisantă... salvezi și câștigi spațiu!

■ **Ușile glisante** au avantajul posibilității de a câștiga spațiu în locurile ocupate în mod obișnuit de ușa batantă atunci când este deschisă. Astfel, pentru a exemplifica mai clar ce economie de spațiu se realizează dacă optăm pentru uși glisante, dăm următorul exemplu: să spunem că într-o casă avem un număr de 8 uși. Optându-se pentru uși glisante se obțin 8 m² spațiu în plus, pe care îi putem amenaja fără a fi limitați de locurile ce rămân neutilizabile din cauza foilor de ușa batante ce trebuie să aibă spațiu disponibil pentru deschidere. Sistemele de uși glisante de la Eclisse s-au dovedit de-a lungul timpului cele mai bune soluții de gestionare economică a spațiului, devenind standardul în domeniu, în pas cu inovațiile tehnice actuale.

Ital Styl oferă posibilitatea de a adapta orice model de ușa de interior la sistemele glisante Eclisse.

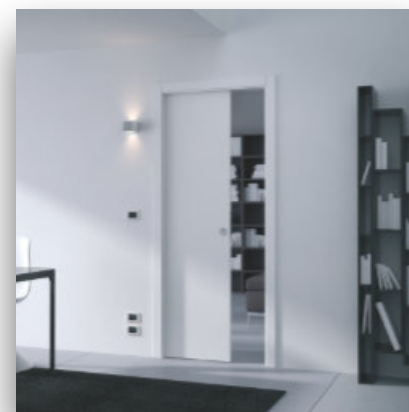
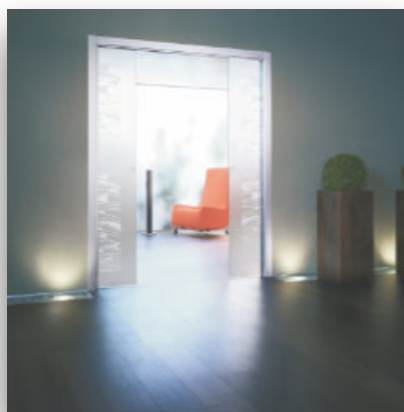

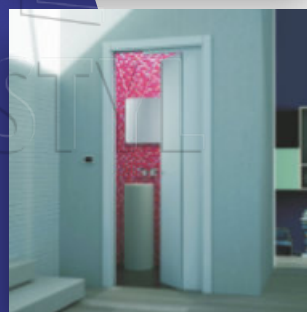
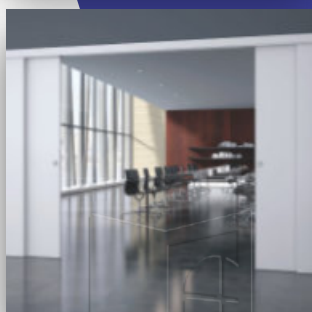
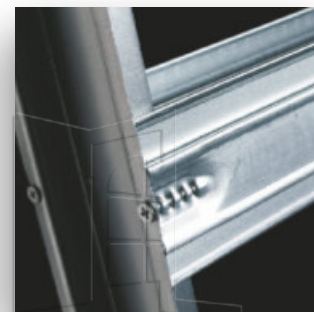







140





Din PORTOFOLIUL
ITALSTYL









ITALSTYL

Leam prin excelență



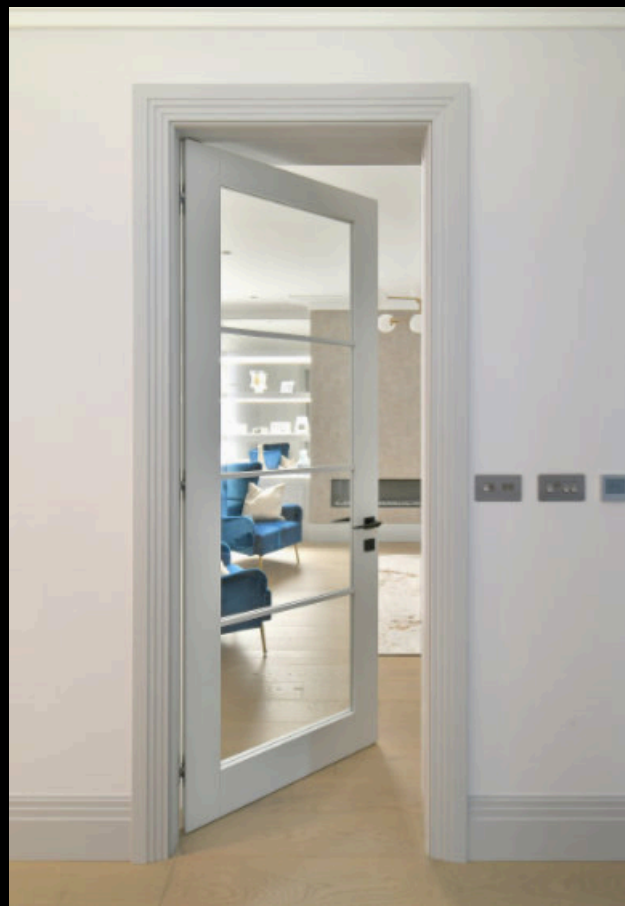
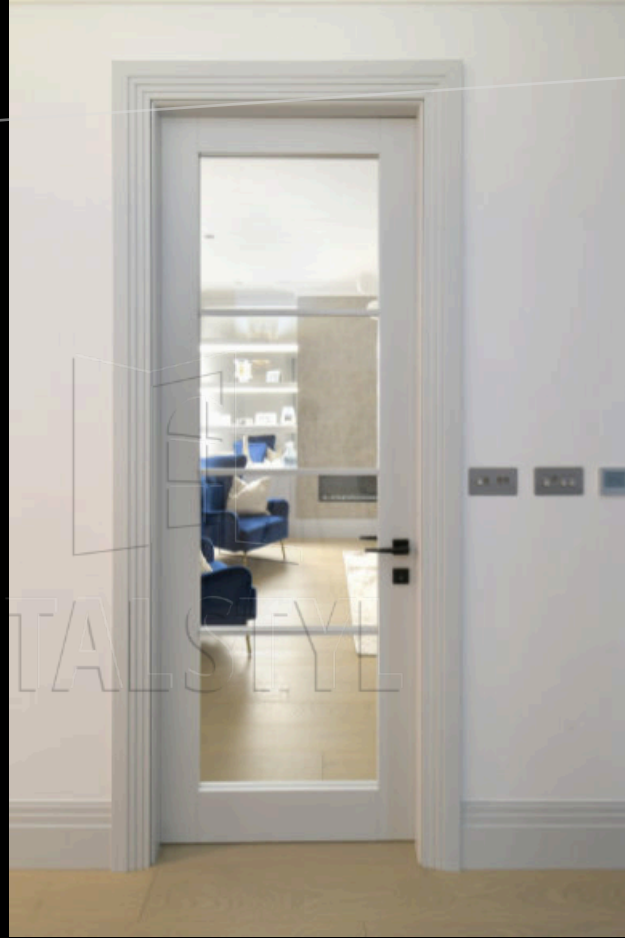
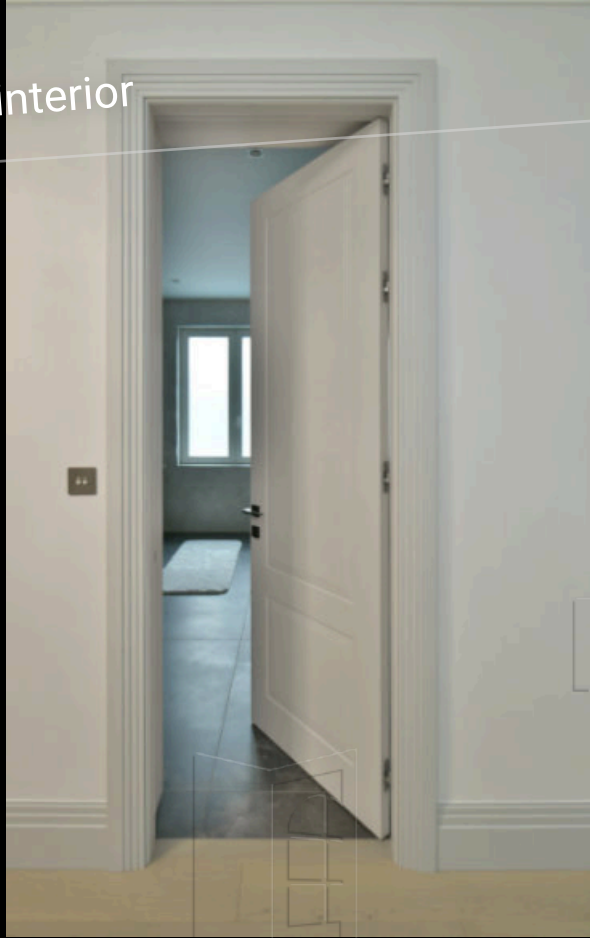



ITALSTYL
Lenă prin excelență







ITALSTYL

Lemn prin excelență









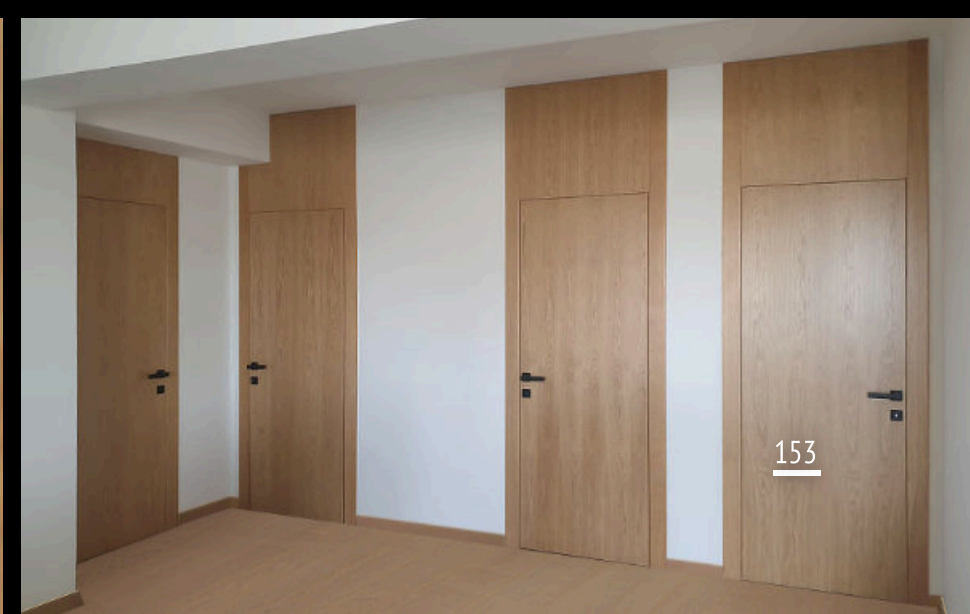

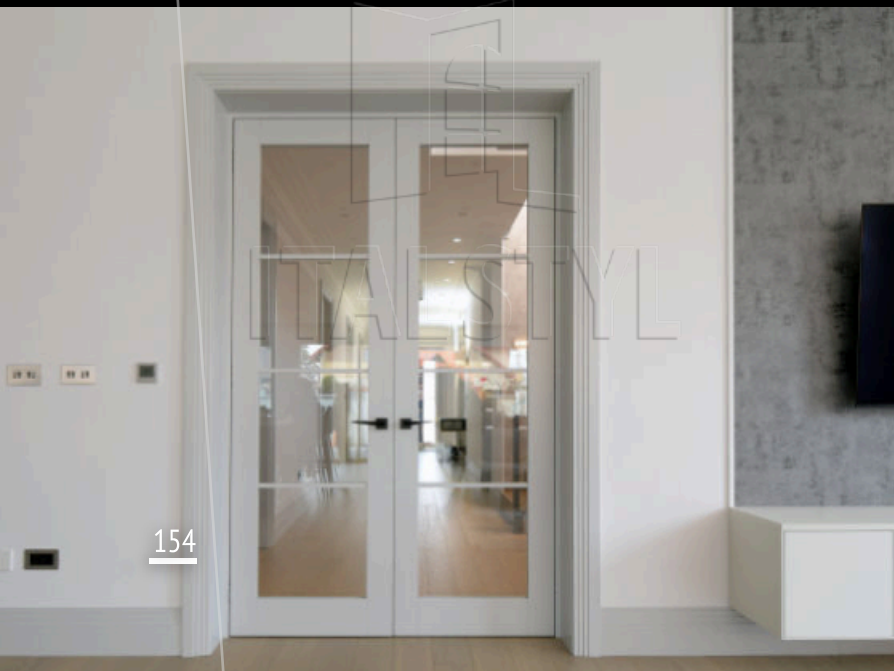





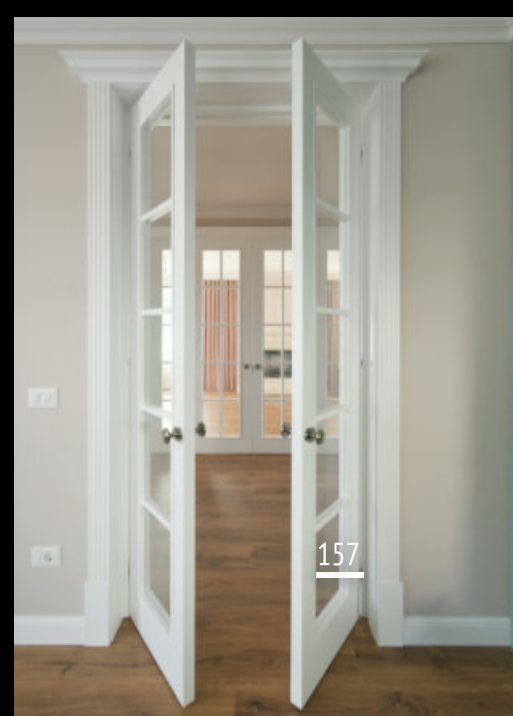













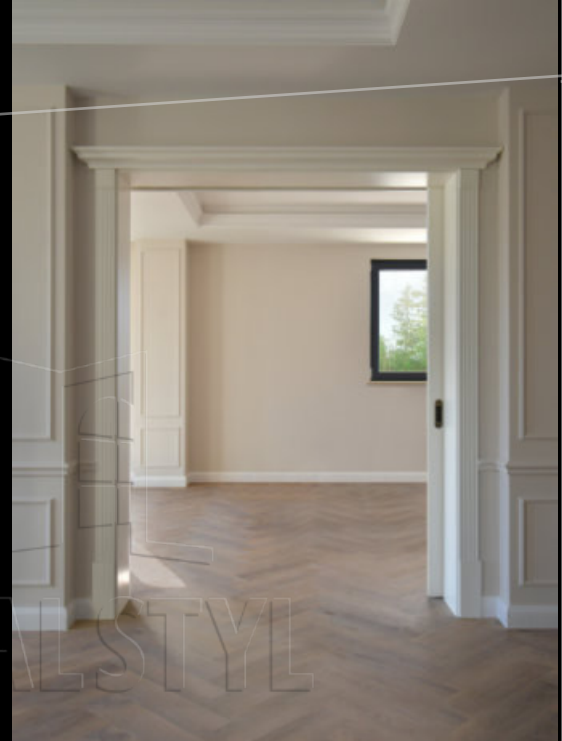

Glisante clasice



Glisante moderne

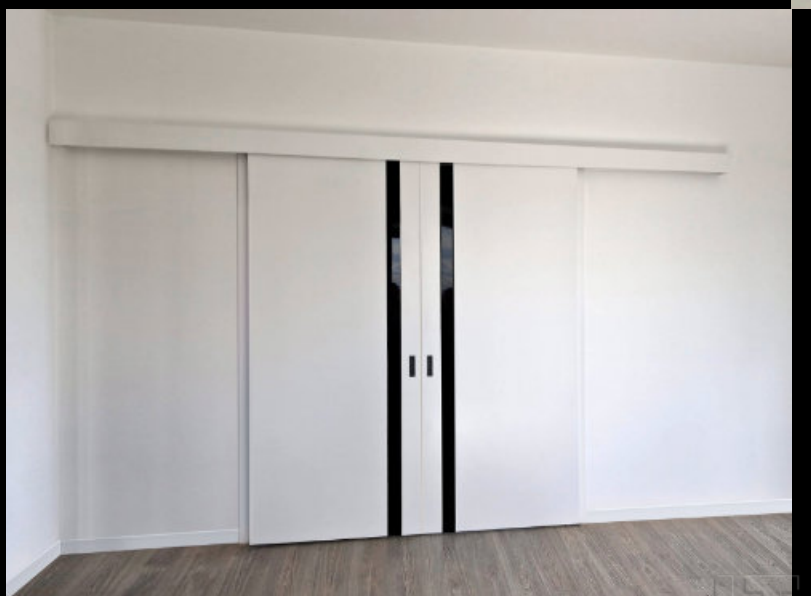

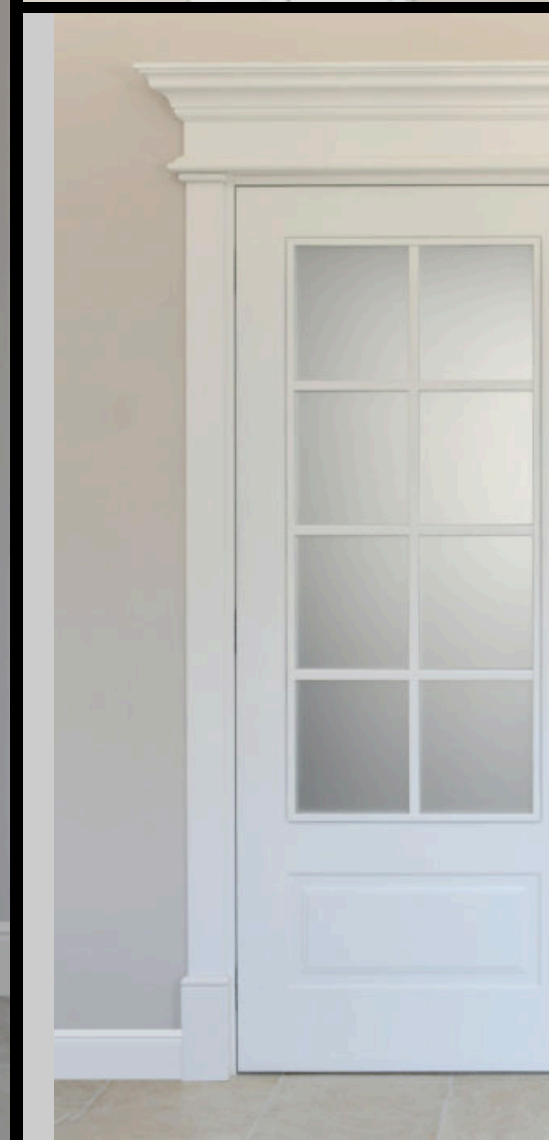



 **ITALSTYL** Uși interior





Showroom



Vezi showroom



ITALSTYL





ITALSTYL
Lemn prin excelență



ITALSTYL

vă oferă

- Uși de interior
- Uși batante
- Uși glisante
- Uși din sticlă
- Uși pentru hoteluri



- Uși de intrare
- Uși pentru terase
- Ferestre
- Placări lemn
- Parchet și plintă

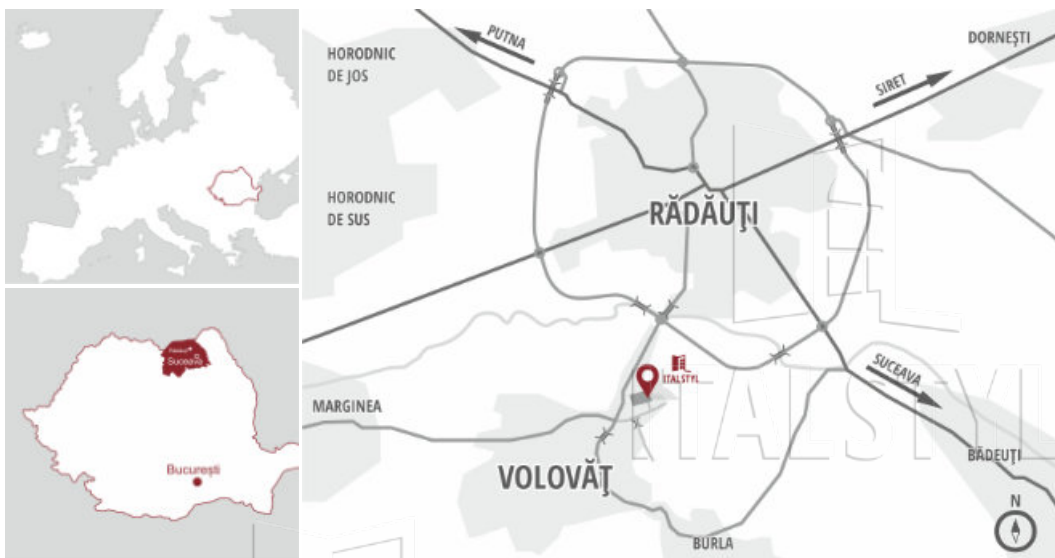

ITALSTYL



ITALSTYL

Lemn prin excelență

ITAL STYL SRL

727615 Volovăț, str. Fabricii nr. 3,

Jud. SUCEAVA, ROMÂNIA

Tel./Fax: +40 230 419 501

E-mail: sales@italstyl.ro

web: italstyl.ro



ITALSTYL

Tipărit de:  **MASTERPRINT**
Design, foto: Ovidiu Prelipcean



ITALSTYL
Lemn prin excelență

uși de interior

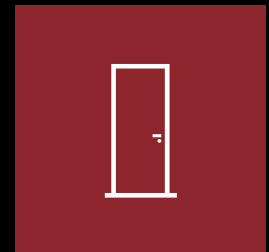
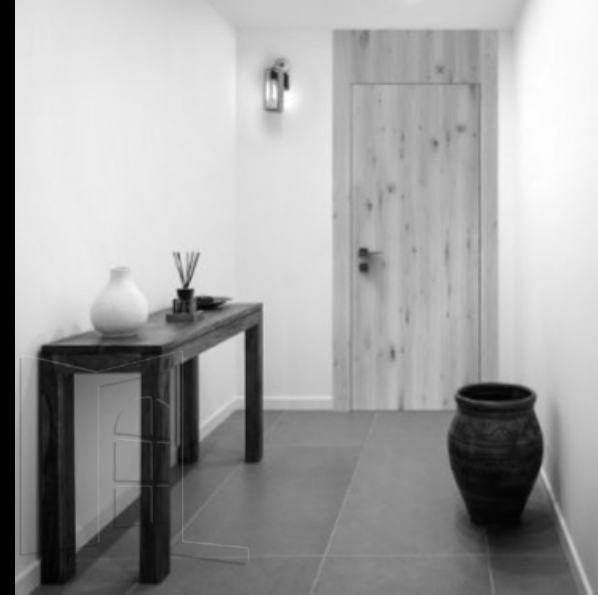



CATALOG UȘI INTERIOR

ITAL STYL



ITALSTYL

Lemn prin excelență

e-book (PDF)

pentru o experiență cât mai bună pe LAPTOP/DESKTOP activați vizualizare pe 2 pagini
uși de interior

